

Address

Shipping address  see address

Com.:

Order  
 Estimate



**Basic Price 3230,- €**

Price valid from January 1st 2026  
(until revoked)

Purchaser: \_\_\_\_\_  
 Telephone: \_\_\_\_\_

# Kayou



All dimensions in cm  
Dimensional tolerances +/- 0,5cm

Capacity up to 50 kg  
user weight: \_\_\_\_\_ kg

light active wheelchair for kids with rigid aluminium frame

| basic measures                    |   |   |   |  |
|-----------------------------------|---|---|---|--|
| frame size                        | seat width (SW)   | seat depth (SD)   | back height (BH)  | Lower Leg Length (LLL):  |
| <input type="checkbox"/> size 20" | <input type="checkbox"/> 18 <input type="checkbox"/> 20 <input type="checkbox"/> 22 <input type="checkbox"/> 24 <input type="checkbox"/> 26                             | <input type="checkbox"/> 18 <input type="checkbox"/> 20 <input type="checkbox"/> 22 <input type="checkbox"/> 24 <input type="checkbox"/> 26   | <input type="checkbox"/> 15 <input type="checkbox"/> 17,5 <input type="checkbox"/> 20   | LLL: .....<br>respective cushion<br>or                                       |
| <input type="checkbox"/> size 22" | <input type="checkbox"/> 20 <input type="checkbox"/> 22 <input type="checkbox"/> 24 <input type="checkbox"/> 26 <input type="checkbox"/> 28                             | <input type="checkbox"/> 20 <input type="checkbox"/> 22 <input type="checkbox"/> 24 <input type="checkbox"/> 26 <input type="checkbox"/> 28 <input type="checkbox"/> 30                             | <input type="checkbox"/> 22,5 <input type="checkbox"/> 25 <input type="checkbox"/> 27,5 | LLL: .....<br>respective seat plate<br>(without seat cushion)                |
| <input type="checkbox"/> size 24" | <input type="checkbox"/> 22 <input type="checkbox"/> 24 <input type="checkbox"/> 26 <input type="checkbox"/> 28 <input type="checkbox"/> 30 <input type="checkbox"/> 32 | <input type="checkbox"/> 22 <input type="checkbox"/> 24 <input type="checkbox"/> 26 <input type="checkbox"/> 28 <input type="checkbox"/> 30 <input type="checkbox"/> 32 <input type="checkbox"/> 34 | <input type="checkbox"/> 30 <input type="checkbox"/> 32,5 <input type="checkbox"/> 35   | (the max. LLL is depends on the seat height)<br>Technical data see back side |

## Kayou-CARBON

Kayou-CARBON - Abduction frame

**basic equipment**

- # light aluminium frame with abduction
- # castor
- # rear wheel

**Carbon special design**

- # back shell made of carbon
- # footrest made of carbon
- # seat plate made of carbon
- # sideguard made of carbon

Note: only with the special design discount

Code 2600 basic price **3230,- €**

+

Code 2609 Carbon additional price **2395,- €**

## Kayou

Kayou - abduction frame

**basic equipment:**

- # light aluminium frame with 12cm abduction
- # with seat plate made of aluminium
- # footrest plate made of aluminium
- # aluminium side guard with aluminium back shell (without cushion)
- # castor
- # rear wheel

Code 2600

**basic price 3230,- €**

| seat height |   |
|-------------|---|
|             | <p>Seat height in cm<br/>see possible wheel combination<br/>(without seat cushion)</p> <p>front: _____ cm</p> <p>back: _____ cm</p> |

Technical changes and print mistakes reserved.

VD2377E-18

## Technical data

### seat width **SW**

from outside crossbar to outside crossbar +6mm

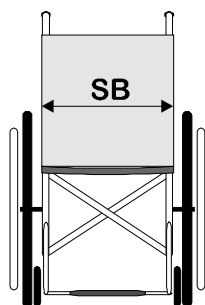

### seat depth **SD**

from back tube to upper edge seat upholstery

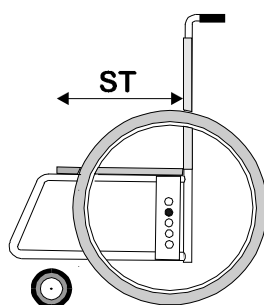

### back height **RH**

from upper edge seat upholstery to upper edge back upholstery

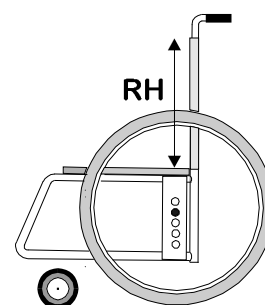

### Lower Leg Length LLL:

13 to 34 cm

### Total width wheelchair:

with wheels and handrim

at 7° camber

at 9° camber

at 11° camber

SW + 30cm

SW + 33cm

SW + 36cm





















## Seat height **SH**















Kayou









| Rear wheel | Castor fork | minimum seat height |         | maximum seat height |          |
|------------|-------------|---------------------|---------|---------------------|----------|
|            |             | front               | back    | front               | back     |
| 20 inch    | 4 inch      | 32 cm               | 32 cm   | 37,5 cm             | 37,5 cm  |
|            | 5 inch      | 32 cm               | 32 cm   | 37,5 cm             | 37,5cm   |
| 22 inch    | 4 inch      | 34,5 cm             | 34,5 cm | 40 cm               | 40 cm    |
|            | 5 inch      | 34,5 cm             | 34,5 cm | 40 cm               | 40 cm    |
| 24 inch    | 4 inch      | 36,5 cm             | 36,5 cm | 44,5 cm*            | 44,5 cm* |
|            | 5 inch      | 36,5 cm             | 36,5 cm | 44,5 cm*            | 44,5 cm* |

All measurements ± 0,5 cm

\* for Kayou CARBON max. seat height front: 42cm back: 40cm

| frame colour |  | Because of the material are different colours possible   |  |  |                  |  |  |
|--------------|--|--|--|--|------------------|--|--|
| shiny        | <input type="checkbox"/>  25 RAL9010 white              | <input type="checkbox"/>  06 dormant red              | <input type="checkbox"/>  44 RAL5015 sky blue met.    | <input type="checkbox"/>  51 apple green metallic |                  |  |  |
|              | <input type="checkbox"/>  56 RAL1021 gold yellow met.   | <input type="checkbox"/>  40 red metallic             | <input type="checkbox"/>  16 RAL5002 ultramarine blue | <input type="checkbox"/>  45 RAL6018 yellow green |                  |  |  |
|              | <input type="checkbox"/>  24 RAL1028 melony yellow      | <input type="checkbox"/>  43 RAL4010 telemagenta met. | <input type="checkbox"/>  17 dormant blue             | <input type="checkbox"/>  60 mojit green met.     |                  |  |  |
|              | <input type="checkbox"/>  27 mandarin met.              | <input type="checkbox"/>  53 cassis                   | <input type="checkbox"/>  64 petrol green met.        | <input type="checkbox"/>  19 silver metallic      |                  |  |  |
|              | <input type="checkbox"/>  41 RAL3020 trafficed red met. | <input type="checkbox"/>  59 atlantic blue met.       | <input type="checkbox"/>  50 apple green              | <input type="checkbox"/>  23 RAL9005 black        | met. = metalized |  |  |

| frame colour  |  | Because of the material are different colours possible   |   |                  |  |  |  |
|---------------|--|--|---|------------------|--|--|--|
| mat / satined | <input type="checkbox"/>  76 white satined            | <input type="checkbox"/>  69 purpur met. satined        | <input type="checkbox"/>  75 petrol green met. satined |                  |  |  |  |
|               | <input type="checkbox"/>  65 gold yellow met. satined | <input type="checkbox"/>  61 cool mint mat              | <input type="checkbox"/>  73 yellow green met. satined |                  |  |  |  |
|               | <input type="checkbox"/>  66 mandarin met. satined    | <input type="checkbox"/>  72 sky blue met. satined      | <input type="checkbox"/>  74 mojit green met. satined  |                  |  |  |  |
|               | <input type="checkbox"/>  67 traffic red satined      | <input type="checkbox"/>  71 atlantic blue met. satined | <input type="checkbox"/>  77 silver metallic satined   |                  |  |  |  |
|               | <input type="checkbox"/>  68 telemagenta met. satined | <input type="checkbox"/>  70 ultramarine blue satined   | <input type="checkbox"/>  22 RAL9011 black mat         | met. = metalized |  |  |  |

| upholstery colours           |  |  |
|------------------------------|--|--|
| upholstery breathable fabric | <input type="checkbox"/>  AG410 yellow      | <input type="checkbox"/>  AG451 king blue |
|                              | <input type="checkbox"/>  AG430 red         | <input type="checkbox"/>  AG460 lemon     |
|                              | <input type="checkbox"/>  AG441 pink        | <input type="checkbox"/>  AG470 grey      |
|                              | <input type="checkbox"/>  AG450 ultramarine | <input type="checkbox"/>  AG490 black     |

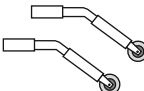
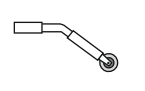
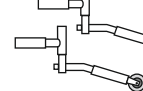

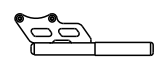
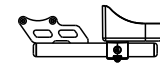
| frame accessories   |  |  |  |
|---|--|--|--|
| <p>2 anti-tip wheels right and left height adjustable, swing away upturned</p>  <p>Code 2604</p> | <p>anti-tip wheel, central height adjustable, swing away</p> <p>from SW 22 possible</p>  <p>Code 2606</p> | <p>2 anti-tip wheels right and left height adjustable, swing away forward</p>  <p>Code 2605</p> |  |
| <input type="checkbox"/> Pair 332,- €   | <input type="checkbox"/> Piece 208,- €   | <input type="checkbox"/> Paar 349,- €  |  |

| frame accessories  |  |  |   | not in combination with Carbon parts |                                   |  |  |
|--|--|--|---|--------------------------------------|-----------------------------------|--|--|
| <p>Tip shackle</p> <p><input type="checkbox"/> right<br/><input type="checkbox"/> left</p>  <p>Code 2602</p> <p>from SW 22 possible<br/>not in combination with 2 anti-tip wheel (not with CODE 2604 or 2605)</p> | <p>Walking stick holder</p> <p>Note:<br/>only 2 pieces of tip shackle or walking stick holder is possible !!</p> <p><input type="checkbox"/> right<br/><input type="checkbox"/> left</p>  <p>Code 2603</p> <p>from SW 22 possible<br/>not in combination with 2 anti-tip wheel (not with CODE 2604 or 2605)</p> | <p>Edition "TRI-COLOR-K1" Kayou</p> <p>Colour 1: _____<br/>- frame</p> <p>Colour 2: _____<br/>- seat plate<br/>- side guard<br/>- back plate<br/>- push handle *</p> <p>Colour 3: _____<br/>- foot plate<br/>- Design fork</p> | <p>Edition "DUO-K1" Kayou</p> <p>Colour 1: _____<br/>- frame<br/>- seat plate<br/>- side guard<br/>- back plate<br/>- push handle *</p> <p>Colour 2: _____<br/>- foot plate<br/>- Design fork</p> | * only when you choose the option    | * only when you choose the option |  |  |
| <input type="checkbox"/> Piece 98,- €  | <input type="checkbox"/> Piece 119,- €   | <input type="checkbox"/> Code 2698-1 OE 282,- €  | <input type="checkbox"/> Code 2699-1 OE 236,- €   |                                      |                                   |  |  |



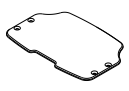
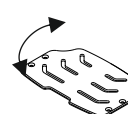
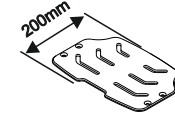
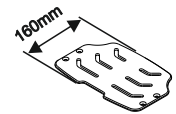

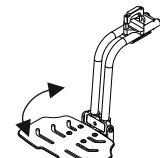
Technical changes and print mistakes reserved.

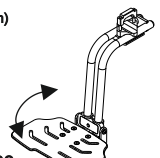

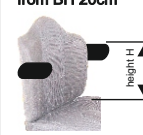

VD2377E-18

| Kayou CARBON  |  | footrest   |  | Kayou  |  |
|---|--|--|--|--|--|
| Single footrest plate CARBON, continuously variable and height adjustable and angle adjustable, (CARBON)<br><br><input type="checkbox"/> Code 2630 |  | Single footrest plate, stepless, height adjustable and angle adjustable and backwards foldable<br><br><input type="checkbox"/> Code 2635 | single footrest plate deep continuously variable and height adjustable and angle adjustable<br><br><input type="checkbox"/> Code 2637 | Single footrest plate, continuously variable and height adjustable and angle adjustable<br><br><input type="checkbox"/> Code 2631 |  |
| <b>Standard</b> only in combination with Code 2609  |  | <input type="checkbox"/> Piece OE 218,- €  | <input type="checkbox"/> Piece OE 86,- €   | <b>Standard</b>  |  |

| Kayou CARBON   |  | footrest  |  | Kayou  |  |
|--|--|---|--|--|--|
| Single footrest plate CARBON munted central and bent backwards foldable *<br>only in combination with Code 2609<br><br>Code 2634<br>* not in combination with TRIKE-Mono<br><input type="checkbox"/> Piece OE 406,- € |  | Single footrest flat profile, stepless height adjustable and angle adjustable<br><br>Code 2632<br><input type="checkbox"/> Piece OE 122,- € |  | Single footrest plate, mounted central, bent backward foldable * (up to LLL 20cm)<br><br>Code 2633<br>* not in combination with TRIKE-Mono<br><input type="checkbox"/> Piece OE 298,- € |  |

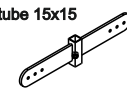
| Kayou CARBON  |  | back   |  | Kayou  |                 |
|---|--|--|--|--|-----------------|
| Curved back made of CARBON (without cushion) without push handle<br><br>curved back 30mm depth<br><input type="checkbox"/> Code 2628 |  | Curved back plate aluminium 50 (without cushion) without push handle<br>curved back plate 50mm depth<br>Code 2621<br><input type="checkbox"/> Piece OE 214,- € |  | Curved back plate aluminium 30 (without cushion) without push handle<br>curved back plate 30mm depth (standard)<br>Code 2620<br><input type="checkbox"/> Code 2620 | <b>Standard</b> |

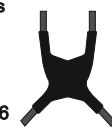
| back  |  |   |   |   |  |
|---|--|---|---|---|--|
| 2 single push handles height adjustable (without joint) from SW 22cm<br><br>Code 2627<br><input type="checkbox"/> Piece OE 349,- € | push bow with joint push bow with plastic joint<br>push bow form<br><input type="checkbox"/> trapeze form<br>Code 2623<br><input type="checkbox"/> U form<br>Code 2623U from SW 22cm<br><br><input type="checkbox"/> Piece OE 436,- € | side pads fixed with attachment (Ag490 black) from BH 20cm<br><br><input type="checkbox"/> size S<br><input type="checkbox"/> size M<br>height of the side pad: _____ mm<br>Code 2626 (from the seat area backside until upper edge of the pad)<br><input type="checkbox"/> Pair 262,- € | back cushion Kayou ergonomic back unit (for curved back)<br><br><input type="checkbox"/> 50mm curve depth<br><input type="checkbox"/> 30mm curve depth<br>Code 2624<br><input type="checkbox"/> Piece OE 419,- € | cushion size of the anatomic formed back = 3cm<br><input type="checkbox"/> Code 2622<br><input type="checkbox"/> Piece OE 402,- € |  |

| accessories  |   |   |   |  |   |   |
|--|---|---|---|--|---|---|
| Head pad „light“ adjustable, aluminium (mounted at the back plate)<br><br>Code 2689<br><input type="checkbox"/> Piece 330,- € | Positionierungshilfe für Kopfstütze „light“ Ø19mm<br>Code 2689P<br><input type="checkbox"/> Pcs. 62,- € | attachment for head rest for head rest tube:<br><input type="checkbox"/> 15x15mm Code 2688H<br><input type="checkbox"/> Ø 19mm Code 2689H<br>(without head pad)<br><input type="checkbox"/> Piece 188,- € | Holder for chest harness on the vertical head rest tube 15x15<br>Code 2687V<br><br>on the vertical head rest tube Ø18,7<br>Code 2687<br><br>only in combination with CODE 2689<br><input type="checkbox"/> Piece OE 134,- € | chest harness, black with folding buckles and straps<br><br>Code 2686<br>- without head rest: assembly on back plate<br>- with head rest: with holder for chest harness (with CODE 2689 + 2687)<br><input type="checkbox"/> Piece OE 219,- € | Mono-push handle standard (without joint) with special crossbar at push handle holder fixed (only to SW 28cm)<br><br>Code 2623S<br><input type="checkbox"/> Piece OE 339,- € | Mono-push handle with gear segment (steel) with special crossbar at the push handle holder with gear segment pivot around Mono push handle at an angle to adjust (not completely folded down!)<br><br>Code 2623MS<br><input type="checkbox"/> Stück OE 452,- € |

Technical changes and print mistakes reserved.





VD2377E-18

| overview back Kayou |    |    |    |    |    |    |    |    |
|---------------------|----|----|----|----|----|----|----|----|
| BH \ SW             | 18 | 20 | 22 | 24 | 26 | 28 | 30 | 32 |
| 15                  |    |    |    |    |    |    |    |    |
| 17,5                |    |    |    |    |    |    |    |    |
| 20                  |    |    |    |    |    |    |    |    |
| 22,5                |    |    |    |    |    |    |    |    |
| 25                  |    |    |    |    |    |    |    |    |
| 27,5                |    |    |    |    |    |    |    |    |
| 30                  |    |    |    |    |    |    |    |    |
| 32,5                |    |    |    |    |    |    |    |    |
| 35                  |    |    |    |    |    |    |    |    |
| 37,5                |    |    |    |    |    |    |    |    |
| 40                  |    |    |    |    |    |    |    |    |

 possible combinations of seat width and back height

Technical changes and print mistakes reserved.

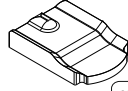
VD2377E-18

| Kayou CARBON  |  | seat  |   | Kayou  |  |
|---|--|---|---|--|--|
| seat plate CARBON<br>with seat plate made of<br>CARBON<br><br><br><br><input type="checkbox"/> Code 2617 |  | cushion standard,<br>compounded foam<br>with cover breathable<br>fabric .....<br><br><br>3 cm<br><br>Code 2612<br><br><input type="checkbox"/> Piece 112,- € | Seat cushion Kayou<br>ergonomic seat cushion<br>extreme light ergonomic<br>formed seat cushion<br><br><br><br>Code 2610<br>seat cushion size of<br>the anatomic formed<br>seat cushion<br>frontside 5cm<br>backside 3cm<br><br><input type="checkbox"/> Piece 492,- € | seat standard<br>with seat plate<br>made of aluminium<br><br><br><br><input type="checkbox"/> Code 2618 |  |
| <b>Standard</b> only in combination<br>with Code 2609   |  |   |   | <b>Standard</b>  |  |

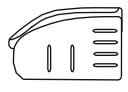
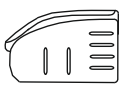
| Kayou CARBON  |   | side guard   |  | Kayou   |  |
|---|---|--|--|---|--|
| Side guard made of CARBON<br>with plastic wheel cover<br>black<br><br><br><br><input type="checkbox"/> Code 2643 | seat belt black<br>with metal lock<br><br><input type="checkbox"/> small (to SW 26)<br><input type="checkbox"/> big (to SW 28)<br><br>without pad      with pad<br><br>Code 2611      Code 2611P<br><br><input type="checkbox"/> <input type="checkbox"/> | Four-point lap belt<br>with metal lock<br>with pad<br><br>Code 2611P-4<br><br><input type="checkbox"/> Piece 202,- € |  | Side guard, aluminium<br>with plastic wheel cover<br>black<br><br><br><br><input type="checkbox"/> Code 2640 |  |
| <b>Standard</b> only in combination<br>with Code 2609   |   |  |  | <b>Standard</b>   |  |

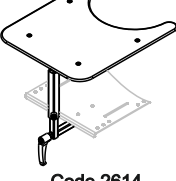
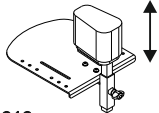
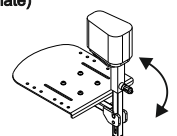
| accessories - seat   |  |   |  |  |      |   |   |   |             |     |       |     |            |       |       |     |        |      |      |      |        |     |     |      |                   |         |         |           |
|--|--|---|--|--|------|---|---|---|-------------|-----|-------|-----|------------|-------|-------|-----|--------|------|------|------|--------|-----|-----|------|-------------------|---------|---------|-----------|
| Therapy table pluggable<br>mounting under seat plate<br><br><br><br>Code 2614<br><br><input type="checkbox"/> Piece 482,- € | Breite Tischplatte:<br><input type="checkbox"/> 25 cm<br><input type="checkbox"/> 30 cm<br><input type="checkbox"/> 35 cm<br><br>combination with footplate middle<br>CODE 2633 is possible<br><br>combination with CODE 2616 only additional<br>with special Code 2616-4 possible<br><br>not in combination with Code 2615<br>not in combination with CARBON-seat plate | Abduction cotter pluggable<br>with holder on the seat plate<br>(alu seat plate)<br><br><br><br>Code 2616<br>size: _____<br><br>In combination with Code 2614 you have to<br>use additional the special CODE 2616-4<br><br><input type="checkbox"/> Piece 249,- € | Abduction cotter removable<br>with holder on the seat plate<br>(alu seat plate)<br><br><br><br>Code 2615<br>size: _____<br><br><input type="checkbox"/> Piece 368,- € | Abduction cotter measure<br><br><table border="1"> <thead> <tr> <th>size</th> <th>1</th> <th>2</th> <th>3</th> </tr> </thead> <tbody> <tr> <td>width front</td> <td>6cm</td> <td>7,5cm</td> <td>9cm</td> </tr> <tr> <td>width back</td> <td>4,5cm</td> <td>5,5cm</td> <td>7cm</td> </tr> <tr> <td>length</td> <td>10cm</td> <td>12cm</td> <td>14cm</td> </tr> <tr> <td>height</td> <td>8cm</td> <td>8cm</td> <td>10cm</td> </tr> <tr> <td>for<br/>Seat width</td> <td>18 - 22</td> <td>24 - 32</td> <td>(30 - 32)</td> </tr> </tbody> </table> | size | 1 | 2 | 3 | width front | 6cm | 7,5cm | 9cm | width back | 4,5cm | 5,5cm | 7cm | length | 10cm | 12cm | 14cm | height | 8cm | 8cm | 10cm | for<br>Seat width | 18 - 22 | 24 - 32 | (30 - 32) |
| size   | 1  | 2   | 3  |  |      |   |   |   |             |     |       |     |            |       |       |     |        |      |      |      |        |     |     |      |                   |         |         |           |
| width front  | 6cm  | 7,5cm   | 9cm  |  |      |   |   |   |             |     |       |     |            |       |       |     |        |      |      |      |        |     |     |      |                   |         |         |           |
| width back   | 4,5cm  | 5,5cm   | 7cm  |  |      |   |   |   |             |     |       |     |            |       |       |     |        |      |      |      |        |     |     |      |                   |         |         |           |
| length   | 10cm   | 12cm  | 14cm   |  |      |   |   |   |             |     |       |     |            |       |       |     |        |      |      |      |        |     |     |      |                   |         |         |           |
| height   | 8cm  | 8cm   | 10cm   |  |      |   |   |   |             |     |       |     |            |       |       |     |        |      |      |      |        |     |     |      |                   |         |         |           |
| for<br>Seat width  | 18 - 22  | 24 - 32   | (30 - 32)  |  |      |   |   |   |             |     |       |     |            |       |       |     |        |      |      |      |        |     |     |      |                   |         |         |           |

| castor  |   |  |   |  |
|---|---|--|---|--|
| Castor solid with design fork black<br><br><input type="checkbox"/> 4" Skater Code 2650<br><input type="checkbox"/> 4" grey Code 2651<br><input type="checkbox"/> 5" grey Code 2652<br><input type="checkbox"/> 5" black Code 2652S | plastic rim black with<br>black PU tyre<br><br><input type="checkbox"/> 4" PU solid black<br>Code 2657<br><input type="checkbox"/> 5" PU solid black<br>Code 2659 | Castor solid with<br>plastic rim black<br>and black tyre<br><br><input type="checkbox"/> 4" Code 2653<br><input type="checkbox"/> 5" Code 2654 | Castor SOFT solid with<br>aluminium rim silver<br>and black SOFT tyre<br><br><input type="checkbox"/> 4" Code 2655<br><input type="checkbox"/> 5" Code 2656 | Castor SOFT solid with<br>aluminium rim black<br>and black SOFT tyre<br><br><input type="checkbox"/> 4" Code 2655S<br><input type="checkbox"/> 5" Code 2656S |
| <b>Standard</b>   |   | <input type="checkbox"/> Pair OE 48,- €  | <input type="checkbox"/> Pair OE 78,- €   | <input type="checkbox"/> Pair OE 78,- €  |
|   |   | <input type="checkbox"/> Pair OE 66,- €  |   |  |

| castor  |  |  |
|---|--|--|
| Lightwheel castor with LED<br>with design fork black<br><br><input type="checkbox"/> 4" Code 2651LED<br><input type="checkbox"/> 5" Code 2652LED<br><br><input type="checkbox"/> Pair OE 54,- € | Design fork coloured<br><br>colour: _____<br><br>Code 499<br><br>(see frame colour on page 3)<br><br><input type="checkbox"/> Pair OE 98,- € | Bumper wheel 63mm<br>at castor adapter<br>(with extra cover)<br><br>Code 2695<br><br><input type="checkbox"/> Pair OE 99,- € |

Technical changes and print mistakes reserved.

VD2377E-18

**overview measures**

*Seat and back cushion Kayou*

total height back cushion = back height+35mm

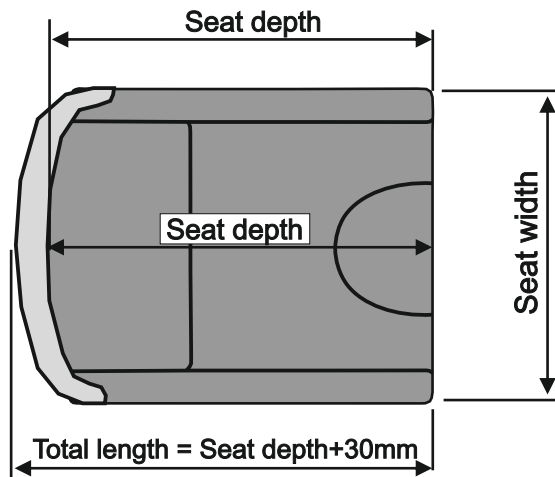
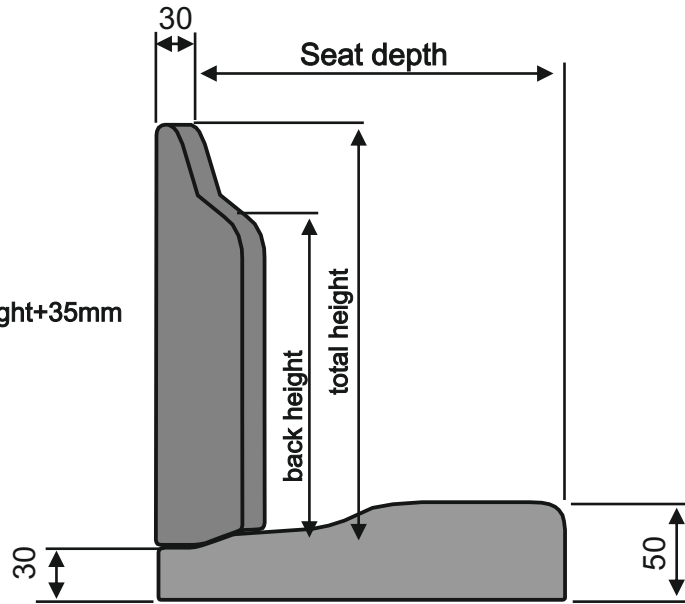

**Note:**  
at Kayou with 50mm curved back depth  
is the seat depth = seat depth +20mm

**Note:**

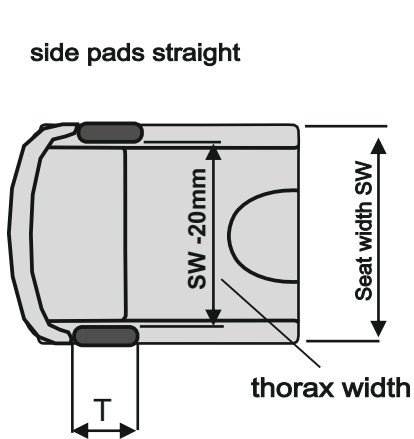

Height of side pads: \_\_\_\_\_ mm  
(from the seat area backside untill upper edge of the side pad)

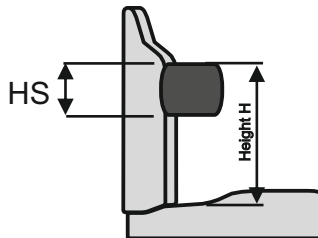

| measure side pads | depth T | Height HS |
|-------------------|---------|-----------|
| Size S            | 7cm     | 5cm       |
| Size M            | 12cm    | 5cm       |

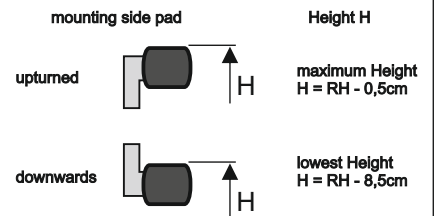

Technical changes and print mistakes reserved.

VD2377E-18

rear wheel

\* SENTINEL (black tyre)

|  |  |   |  |   |  |  |  |   |
|--|--|---|--|---|--|--|--|---|
| <b>Rear wheel standard (Alu hub) with quick release axle</b><br>pneumatic<br><input type="checkbox"/> 20"x1 fine profile Code 2790<br><input type="checkbox"/> 20"x1 black * Code 2791<br><input type="checkbox"/> 22"x1 fine profile Code 2793<br><input type="checkbox"/> 22"x1 black * Code 2794<br><input type="checkbox"/> 24"x1 fine profile Code 2797<br><input type="checkbox"/> 24"x1 black * Code 2798 |  | solid<br><input type="checkbox"/> 20"x1 Code 2680<br><input type="checkbox"/> 20"x1 black Code 2681<br><input type="checkbox"/> 22"x1 Code 2682<br><input type="checkbox"/> 22"x1 black Code 2683<br><input type="checkbox"/> 24"x1 Code 2684<br><input type="checkbox"/> 24"x1 black Code 2685 |  | <b>Design rear wheel 24" (Alu hub silver) with quick release axle, straight spokes wheel</b><br><input type="checkbox"/> 24"x1 pneumatic Code 7391<br><input type="checkbox"/> 24"x1 solidU Code 7392<br><input type="checkbox"/> 24"x1 solid black Code 7393 |  | <b>Performance tyre</b><br>Right Run<br><input type="checkbox"/> 22"x1 Marathon Plus Evolution (black tyre) Code 577<br><input type="checkbox"/> 24"x1 Marathon Plus (grey tyre) Code 570<br><input type="checkbox"/> 24"x1 Marathon Plus Evolution (black tyre) Code 572<br>24"x1 Code 573<br><input type="checkbox"/> red<br><input type="checkbox"/> blue<br><input type="checkbox"/> grey<br><input type="checkbox"/> black<br>22"x1 Code 576<br>black |  | Camber<br>7° <input type="checkbox"/><br>9° (standard) <input type="checkbox"/><br>11° <input type="checkbox"/> |
| Standard   |  |   |  | OE 40,- €   |  |  |  |   |

handrim for rear wheel standard

|   |  |  |  |            |  |            |  |            |   |            |  |                                       |   |  |  |  |   |  |  |  |
|---|--|--|--|------------|--|------------|--|------------|---|------------|--|---------------------------------------|---|--|--|--|---|--|--|--|
| <b>Handrim for rear wheel standard und Design rear wheel 24"</b><br>aluminium black<br><input type="checkbox"/> 20" Code 158<br><input type="checkbox"/> 22" Code 455<br><input type="checkbox"/> 24" Code 454<br>extension narrow <input type="checkbox"/> wide <input type="checkbox"/> |  |  |  |            |  |            | aluminium silver<br><input type="checkbox"/> 22" Code 492<br><input type="checkbox"/> 24" Code 491 |            | stainless steel polished<br><input type="checkbox"/> 20" Code 291<br><input type="checkbox"/> 22" Code 155<br><input type="checkbox"/> 24" Code 156 |            | TETRA-GRIP (Super Grip)<br><input type="checkbox"/> 20" Code 254<br><input type="checkbox"/> 22" Code 252<br><input type="checkbox"/> 24" Code 452 |                                       | GEKKO S black anodized with rubber lip Ø - smaller<br><input type="checkbox"/> 22" Code 4503<br><input type="checkbox"/> 24" Code 4507<br><input type="checkbox"/> narrow <input type="checkbox"/> wide |  | GEKKO black anodized with rubber lip<br><input type="checkbox"/> 22" Code 4501<br><input type="checkbox"/> 24" Code 4508<br>Anbau <input type="checkbox"/> eng <input type="checkbox"/> weit |  | CURVE black anodized<br>CURVE<br><input type="checkbox"/> 22" Code 4502<br>CURVE L<br><input type="checkbox"/> 24" Code 4504<br>extension <input type="checkbox"/> narrow <input type="checkbox"/> wide |  | Hand rim cover black<br><br><input type="checkbox"/> 20" Code 290<br><input type="checkbox"/> 22" Code 191<br><input type="checkbox"/> 24" Code 192 |  |
| Standard  |  |  |  | OE 322,- € |  | OE 506,- € |  | MP 506,- € |   | OE 392,- € |  | <input type="checkbox"/> Pair 138,- € |   |  |  |  |   |  |  |  |



rear wheel

Technical changes and print mistakes reserved.

|  |  |  |  |  |  |   |  |
|--|--|--|--|--|--|---|--|
| <b>Rear wheel with drum brake and quick release axle (for use of companion)</b><br>Nite: only by 9° camber<br><input type="checkbox"/> 20" Code 2660<br><input type="checkbox"/> 22" Code 2661<br><input type="checkbox"/> 24" Code 2662 |  | <b>"Black Edition"</b><br>Drum brake rear wheel with black hub, black rim and quick release with black cap and with tyre Marathon Plus Evolution (black tyre)<br>22"x1 or 24"x1<br>Code 2263<br>(only in combination with CODE 2661 or 2662) |  | <b>SAFETY-GRIP-rear wheel rim with integrated handrim</b><br><input type="checkbox"/> 22" Code 7385<br><input type="checkbox"/> 24" Code 7386<br>only in combination with rear wheel standard or rear wheel with drum brake<br>(combination with CODE 2263 not possible) |  | Brake for companion at mono push handles mounted<br>with special holding and bowden cable for brake lever<br>Code 2669<br>(only in combination with CODE 2660, 2661 or 2662 possible) |  |
| <input type="checkbox"/> Pair OE 332,- €   |  | <input type="checkbox"/> Pair OE 108,- €   |  | <input type="checkbox"/> Pair OE 104,- €   |  | <input type="checkbox"/> Piece OE 182,- €   |  |

light weight wheel

one hand drive

|  |  |  |   |  |   |  |  |  |  |  |
|--|--|--|---|--|---|--|--|--|--|--|
| <b>Light weight wheel LWW with black rim, 24 radial spokes black with black alu hand rim and pneumatic tyre (fine profile)</b><br>grey tyre<br>Alu handrim black anodized<br>20 x1" <input type="checkbox"/> CODE 2965<br>22 x1" <input type="checkbox"/> CODE 2964<br>24 x1" <input type="checkbox"/> CODE 2963<br>Alu handrim silver anodized<br>CODE 2965S<br>CODE 2964S<br>CODE 2963S<br>black tyre<br>Alu handrim black anodized<br>CODE 2976<br>CODE 2975<br>CODE 2974 |  |  | handrim additional for the driven wheel<br>hanrim in stainless steel<br>Code 198Z<br>(only in combination with an one hand drive set) |  | One hand drive with quick release axle and stainless steel hand rim<br>Combination with drum brake is not possible!! # from SW 20cm # camber 7°<br>left distance handrim right distance handrim<br>22" <input type="checkbox"/> Code 193 normal <input type="checkbox"/> Code 195 normal<br><input type="checkbox"/> Code 2193 narrow <input type="checkbox"/> Code 2195 narrow<br>24" <input type="checkbox"/> Code 194 normal <input type="checkbox"/> Code 196 normal<br><input type="checkbox"/> Code 2194 narrow <input type="checkbox"/> Code 2196 narrow |  |  |  | distance by double handrim<br>normal <br>narrow <br>small distance for small hands |  |
| <input type="checkbox"/> Pair solid not possible OE 102,- €  |  |  | <input type="checkbox"/> Piece OE 145,- €   |  | <input type="checkbox"/> Pair OE 998,- €  |  |  |  |  |  |



rear wheel spoke cover

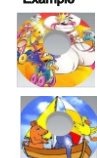

VD2377E-18

|   |  |  |  |   |  |  |  |
|---|--|--|--|---|--|--|--|
| Spoke cover transparent<br><br><input type="checkbox"/> 20 inch Code 164<br><input type="checkbox"/> 22 inch Code 165<br><input type="checkbox"/> 24 inch Code 166 |  | Spoke cover with special motives<br>the prices for extra spokes covers are net prices and not discountable!!<br>www.theramedical.com<br>Motiv-Nr.: <input type="checkbox"/> 24" <input type="checkbox"/> 22" <input type="checkbox"/> 20"<br>The motive nr. you can find at the website see www.theramedical.de<br>Code 2268 |  | www.rs-speichenschutz.com<br>Motiv-Nr.: <input type="checkbox"/> 24" <input type="checkbox"/> 22" <input type="checkbox"/> 20"<br>The motive nr. you can find at the website www.rs-speichenschutz.com<br>Code 2267 |  | Example<br><br>You can find more information of other spoke cover motives at the additional websites. |  |
| <input type="checkbox"/> Pair 180,- €   |  | <input type="checkbox"/> Pair net price 232,- €  |  | <input type="checkbox"/> Pair net price 220,- €   |  |  |  |

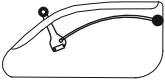
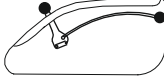
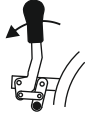

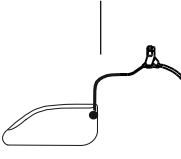
## Overview seat high and lower leg length (LLL) up to the seat plate

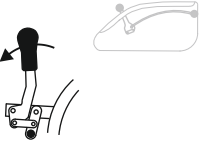
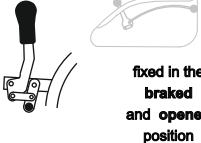
| 20" (wheel 5")  |    |           |      |      |      |      |      |      |    |    |
|---|----|-----------|------|------|------|------|------|------|----|----|
| LLL at 7° camber +0,5cm<br>LLL bei 11° camber -0,5cm  |    | 9° camber |      |      |      |      |      |      |    |    |
| seat height   |    | 31,5      | 32,5 | 33,5 | 34,5 | 35,5 | 36,5 | 37,5 |    |    |
| KAYOU   |    | max.LLL   |      |      |      |      |      |      |    |    |
| seat depth  | 18 | 24        | 25   | 26   | 27   | 28   | 29   | 30   |    |    |
|   | 20 | 24        | 25   | 26   | 27   | 28   | 29   | 30   |    |    |
|   | 22 | 22        | 23   | 24   | 25   | 26   | 27   | 28   |    |    |
|   | 24 | 20        | 21   | 22   | 23   | 24   | 25   | 26   |    |    |
|   | 26 | 20        | 21   | 22   | 23   | 24   | 25   | 26   |    |    |
| 22" (wheel 5")  |    |           |      |      |      |      |      |      |    |    |
| LLL bei 7° camber +0,5cm<br>LLL bei 11° camber -0,5cm |    | 9° camber |      |      |      |      |      |      |    |    |
| seat height   |    | 33,5      | 34,5 | 35,5 | 36,5 | 37,5 | 38,5 | 39,5 |    |    |
| KAYOU   |    | max.LLL   |      |      |      |      |      |      |    |    |
| seat depth  | 20 | 25        | 26   | 27   | 28   | 29   | 30   | 31   |    |    |
|   | 22 | 25        | 26   | 27   | 28   | 29   | 30   | 31   |    |    |
|   | 24 | 25        | 26   | 27   | 28   | 29   | 30   | 31   |    |    |
|   | 26 | 25        | 26   | 27   | 28   | 29   | 30   | 31   |    |    |
|   | 28 | 25        | 26   | 27   | 28   | 29   | 30   | 31   |    |    |
|   | 30 | 25        | 26   | 27   | 28   | 29   | 30   | 31   |    |    |
| 24" (wheel 5")  |    |           |      |      |      |      |      |      |    |    |
| LLL bei 7° camber +0,5cm<br>LLL bei 11° camber -0,5cm |    | 9° camber |      |      |      |      |      |      |    |    |
| seat height   |    | 36        | 37   | 38   | 39   | 40   | 41   | 42   | 43 | 44 |
| KAYOU   |    | max.LLL   |      |      |      |      |      |      |    |    |
| seat depth  | 22 | 27        | 28   | 29   | 30   | 31   | 32   | 33   | 34 | 35 |
|   | 24 | 27        | 28   | 29   | 30   | 31   | 32   | 33   | 34 | 35 |
|   | 26 | 27        | 28   | 29   | 30   | 31   | 32   | 33   | 34 | 35 |
|   | 28 | 27        | 28   | 29   | 30   | 31   | 32   | 33   | 34 | 35 |
|   | 30 | 26        | 27   | 28   | 29   | 30   | 31   | 32   | 33 | 34 |
|   | 32 | 26        | 27   | 28   | 29   | 30   | 31   | 32   | 33 | 34 |
|   | 34 | 25        | 26   | 27   | 28   | 29   | 30   | 31   | 32 | 33 |

| brake  |  |   |   |   |
|--|--|---|---|---|
| Brake integrated in side guard with straight lever and hemisphere 2-piece screwed<br><br><input type="checkbox"/> Code 2670 | Brake integrated in side guard with lever curved and with ball Ø 32mm screwed<br><br><input type="checkbox"/> Code 2671 | Knee angle brake offset, with special mounting (Instead knee angle brake in side guard)<br><br>Code 2674 | Knee angle brake offset with locking pin for locking (Instead knee angle brake in side guard)<br><br>fixed in the braked and opened position<br>Code 2674RD | Brake for companion <b>without</b> brake in side guard with bowden cable for companion control (instead knee angle brake in side guard)<br><br>Code 2678oB<br>Code 2678oBM<br>combination with CODE 2675 or 2675RD is possible II combination with CODE 2670 or 2671 is <u>not</u> possible II |
| <b>Standard</b>  |  | <input type="checkbox"/> Pair OE 149,- €  | <input type="checkbox"/> Pair OE 414,- €  | <input type="checkbox"/> Pair OE 236,- € <input type="checkbox"/> Paar MP 298,- €   |

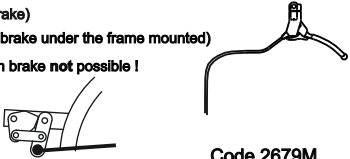
| brake  |  |  |   |   |
|--|--|--|---|---|
| additional knee angle brake offset with special holder mounted under the frame<br><br>Code 2675<br><input type="checkbox"/> Pair OE 269,- € | additional knee angle brake offset with locking pin for locking<br><br>fixed in the braked and opened position<br>Code 2675RD<br><input type="checkbox"/> Pair OE 518,- € | Brake for companion at brake in side guard with additional bowden cable for the companion control only in combination with CODE 2670 or 2671<br><br>Code 2678<br>Combination with drum brake not possible<br><input type="checkbox"/> Pair OE 332,- € | Brake for companion at brake in side guard at <b>Mono push handle</b> with additional bowden cable for the companion control only in combination with CODE 2670 or 2671 only with Code 2623M or 2623S possible!!<br><br>Code 2678M<br>Combination with drum brake not possible<br><input type="checkbox"/> Pair OE 402,- € | Note:<br>with the brake for companion, the companion can fix the brake in the open or closed position.<br><br>Note:<br>with PU-tyre <b>not possible</b> |

| brake   |  |
|---|--|
| additional knee angle brake only for companion, activated with bowden cable (alternative for drum brake) (additional knee angle brake under the frame mounted) Combination with drum brake <b>not possible</b> !<br><br>Code 2679<br><input type="checkbox"/> Pair 368,- € | Code 2679M<br>only for mono push handle (CODE 2623S or 2623M) (with Y - switch)<br><input type="checkbox"/> Pair 445,- € |

| accessories  |  |   |  |
|--|--|---|--|
| <b>Hook for restraint system</b><br>for transport with a wheelchair in a car according to ISO 7176-19 (without pelvic restraint)<br>Retaining eyelets for front frame during the transport in a car.<br>On the frame backside is no additional eyelet necessary.<br>Code 2696R<br><br>additionally you need an extended pelvic belt and the suitable retractors from the specialized trade.<br><input type="checkbox"/> Set net price 184,- € | <b>Pelvic restraint</b><br>for the restraint system 2696R for the attachment to the retractor belts<br>Pelvic restraint for connecting the person with the restraint system<br>Code 2696B<br><input type="checkbox"/> Piece net 96,- € | <b>Anchor plate system</b><br>anchor plates for transport a wheelchair in a car (according to ISO 7176-19).<br>Assembly kit for wheelchair including mounting and with integrated pelvic restraint.<br><br>Code 2697<br><input type="checkbox"/> Set 895,- € |  |

| note   |   |
|--|---|
| Note:<br>The Kayou-CARBON is <b>not allowed</b> transport in the car with the anchor plate system respectively restraint system!!! | Note:<br>the Kombination anchor plate system with One-Handdrive wheels (without drumbrake) is <b>not possible</b> ! |

combination with knee angle brake CODE 2674, 2674RD, 2675 or 2675RD is not possible !

Technical changes and print mistakes reserved.

VD2377E-18

Kayou

accessories

trakkung extension **TRIKE**  
as steering and pushing aid

quick release  
(clamp)

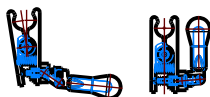

- # holder quick release (clamp) at the bolt in front of the KAYOU frame
- # castor 10x2" black alu fork
- # arrangement of levers with gear segment
- # with ramp as mounting aid

CODE 9926

capacity up to 75kg (wheelchair incl. payload)

# Trike

trakkung extension  
as steering and pushing aid



Piece

704 €

**TRIKE** colour frame

Edition "...-Colour"

|  |  |   |   |
|--|--|---|---|
| <p>Note:<br/>the<br/>TRIKE frame parts<br/>are<br/>made of aluminium</p> | <p>TRIKE- frame colour<br/>powder coated</p> <p>Colour : frame colour (see page 1)</p> <ul style="list-style-type: none"> <li>- frame type right / left</li> <li>- cross tube</li> <li>- castor fork</li> </ul> <p>Code 9908</p> | <p>Edition "Duo-Color"</p> <p>colour 1: _____<br/>(castor fork)</p> <p>colour 2: _____<br/>(frame type right / left, cross tube)</p> <p>Code 9909</p> | <p>Castor fork with brake<br/>for directional stability</p> <p>Code 9909F</p> |
|  | <p>without extra charge <input type="checkbox"/> OE 136,- €</p>  | <p><input type="checkbox"/> OE 146,- €</p>  | <p><input type="checkbox"/> Piece OE 156,- €</p>                              |

note

**Note:**

- Combination TRIKE with anchor plate system is possible !!
- Combination TRIKE with restraint system is possible !!
- Combination TRIKE with bumper wheel is **not** possible !!
- Combination TRIKE-Mono with anchor plate system is possible !!
- Combination TRIKE-Mono with restraint system is possible !!

The transport of the wheelchair with the user in the car combined with the attached TRIKE is **not** allowed !

Kayou

asseccories

trekking extension **TRIKE-Mono**  
with mono bar central mounted  
at the frame

- # holder quick release (clamp) at the bolt in front of the KAYOU frame
- # castor 10x2" black alu fork
- # mono bar telescopic
- # with ramp as mounting aid

CODE 9910

capacity up to 50kg (wheelchair incl. payload)

# Trike-Mono

trekking extension as  
steering and pushing aid

Note:  
by small seat depth, short Lower Leg Length  
and corresponding seat height is an aditions with  
**TRIKE-Mono not possible !!**

Note:  
the Anti-tip wheel central (CODE 2606) is in combination with TRIKE-Mono **not** possible !!  
the single footrest plate mounted central (Code 2633) is in combination with TRIKE-Mono  
**not** possible! (maybe with special footrest 2653150)



Piece

498,- €

**TRIKE** colour frame

Edition "...-Colour"

|  |  |   |   |
|--|--|---|---|
| <p>Note:<br/>the<br/>TRIKE frame parts<br/>are<br/>made of aluminium</p> | <p>TRIKE- frame colour<br/>powder coated</p> <p>Colour : frame colour (see page 3)</p> <ul style="list-style-type: none"> <li>- frame type right / left</li> <li>- cross tube</li> <li>- castor fork</li> </ul> <p>Code 9918</p> | <p>Edition "Duo-Color"</p> <p>colour 1: _____<br/>(castor fork)</p> <p>colour 2: _____<br/>(mono frame tube)</p> <p>Code 9919</p> | <p>Castor fork with brake<br/>for directional stability</p> <p>Code 9909F</p> |
|  | <p>without extra charge <input type="checkbox"/> OE 136,- €</p>  | <p><input type="checkbox"/> OE 146,- €</p>  | <p><input type="checkbox"/> Piece OE 156,- €</p>                              |

Technical changes and print mistakes reserved. VD2377E-18

note

Technical changes and print mistakes reserved.

VD2377E-18

## General Terms and Conditions of Business (GTC)

### Validity

All sales are subject to our delivery and payment conditions, without any exception. Orders and other agreements will not be valid unless confirmed by us in writing. We expressly object to the customer's purchase conditions.

### Quotations and contract conclusion

Quotations are always subject to change, unless they are expressly limited in terms of time. Orders require a written confirmation. After confirmation, prices quoted in orders are fixed but we reserve the right to make adequate price adjustments in the event of price increases for which we are not responsible (e.g. tax increases, wage increases, price changes on the part of our suppliers). Cost estimates for customized products and repairs are always non-binding. We reserve the right to make technical modifications. The contract will not be concluded before the order is confirmed.

### Shipment

To the extent the customer has not made any specification, shipment will be made in usual packaging using an adequate method. Insurance will only be taken out upon request and at the expense of the customer.

Delivery will be made carriage forward. We are free to select a method of shipment. If the customer has special requests, e.g. express delivery, express freight, etc., the additional cost will also be borne by the recipient. The goods will always be shipped at the buyer's risk. In case of damage during transport, the recipient must apply for an ascertainment of the facts with the respective forwarding agent.

### Prices

All prices quoted by BEROLLKA will be quoted ex works, excluding any applicable statutory value added tax, public charges and levies such as potential customs tariffs, and insurance and packaging costs that will be charged separately.

### Minimum quantity surcharge

If a small order is placed with a net value below 20 euros, an additional lump-sum minimum quantity surcharge of 15.00 euros will additionally be charged to cover administrative costs.

### Delivery periods

The delivery dates and periods stated are subject to change. Any delay in delivery will not entitle the customer to withdraw from the contract. The assertion of damage claims is ruled out. BEROLLKA can make partial deliveries for justified reasons.

### Wrong orders / return of merchandise

Any goods erroneously ordered will only be taken back provided we are responsible for such an error and the merchandise is in impeccable condition. In the event that an item erroneously ordered or merchandise that was returned is taken back in an individual case as a gesture of goodwill, attention must be paid to the following:

1. It is necessary to state the article number, the designation of the article, the date and number of the delivery note and the invoice number.
2. The return shipment must be carriage paid.
3. The merchandise must correspond to the article number(s) listed in the delivery note. In no event will any individual parts removed from an article be taken back.
4. The returned merchandise must be in impeccable condition.
5. Processing fees amounting to 10% of the net merchandise value not, however, less than €35.- will be charged for any instance where goods are taken back.

Deliveries effected more than 3 months earlier as well as sewing pieces and customized products cannot be exchanged. A copy of the delivery note or of the invoice will serve as proof in this regard.

### Warranty and notices of defects

Excluding any further claims, the seller is liable for defects of the merchandise in that the seller will mend or replace all those parts free of charge that have become defective or unusable within 6 months due to provable defects of material or workmanship, and of which the seller has been notified in writing immediately after knowledge was gained of the defect. Should longer periods of time be required for statutory reasons, the warranty period is agreed to be 12 months.

The customer must grant the seller the required time and opportunity for effecting delivery of the replacement parts. Replaced parts will become the property of the seller. The buyer must check the merchandise without undue delay after it has been delivered by the seller and, if a defect is found, notify the seller of the defect without undue delay. Should the buyer fail to notify the seller, the merchandise will be deemed accepted unless a defect occurs that could not have been found when the merchandise was checked.

In any event in which a complaint is brought to the notice of BEROLLKA, BEROLLKA invariably has the right to inspect and check the item delivered that is the subject matter of said complaint, for which the customer will grant BEROLLKA the required time and opportunity. BEROLLKA can also demand that the customer sends the item delivered that is the subject matter of a complaint back to BEROLLKA at the expense of BEROLLKA. Should a notice of defects given by the customer turn out to be wilfully or gross negligently unfounded, the customer will be obliged to compensate BEROLLKA for any and all expenses incurred in this connection. BEROLLKA will be entitled to remedy warranty defects at its own discretion either by rectification of the defect or by replacement of the defective part or of the entire item delivered at no cost for the customer. Should the customer itself repair an item that gave rise to a complaint, or should the customer endeavour to rectify the defects itself without prior written approval of the seller, the seller will not grant any claims for reimbursement of expenses (such as transport, road, labour or material costs) or warranty claims.

The following are excluded from the liability for damages:

damage arising from natural wear and tear, damage due to negligent and/or improper treatment, or violent damage. A revocation of the purchase contract, a reduction of the purchase price or damage claims of any kind are ruled out. The warranty obligation will cease if repairs and/or modifications or replacements of individual parts are performed by other parties than the seller or the delivering company.

### Reservation of title

With regard to resellers: The merchandise delivered will remain our property until any and all invoices – also for different deliveries – have been fully paid. Our merchandise that is hence still our property may only be resold within the ordinary course of business. Amounts receivable from any resale are assigned to us. We must be notified without undue delay and on the reseller's own initiative of any disposal of said merchandise outside of the ordinary course of business, e.g. through pledging our property or amounts receivable assigned to us.

### Terms of payment

Any invoices are payable within 30 days from the date of the invoice strictly net cash. A 2% discount will be granted for payments received within 8 days provided any and all payment claims under earlier deliveries have been settled. We are entitled to charge default interest if the 30-day payment deadline is exceeded. The interest rate will be the customary market rate charged by major banks. We expressly reserve the right to effect delivery with cash on delivery.

### Data Protection

BEROLLKA and the customer are responsible themselves for compliance with the respective data protection rules applicable to them. The customer must not provide BEROLLKA with personal data that is illegal or that the customer is not legally authorised to distribute.

### The place of performance and the place of jurisdiction will be the place where the invoice is issued.

Heidelberg, Germany, will be the exclusive place of jurisdiction for any and all disputes arising under the contractual relationship. However, BEROLLKA is entitled to sue the customer at any other legal venue. These General Terms and Conditions of Business are governed by the laws of the Federal Republic of Germany, excluding of the United Nations Convention on Contracts for the International Sale of Goods of Goods (CISG).

Technical modifications and printing errors excepted. A current list of prices can be ordered at any time.