

Address

Shipping address  see address

Order  
 Estimate

Purchaser: \_\_\_\_\_

Telephone: \_\_\_\_\_



**basic price from 2680,- €**

Price valid from January 1st 2026 (until revoked)

All dimensions in cm  
Dimensional tolerances +/- 0,5cm

# Junior 2



Capacity up to 120 kg

user weight: \_\_\_\_\_ kg

### Junior2 SLT

Active children wheelchair made of aluminium, foldable, with **integrated footrest** (without footrest and side guard)

frame straight

SD 26 - 38

Code 221

6cm abduction frame \*

SD 26 - 32 frame short  
SD 34 - 38 frame long

Code 222

**Basic Price 2680,- €**

frame length

**frame straight**      **abduction frame**

51cm = standard (SD 26-38)      54cm = short (SD 26-32)  
57cm = long (SD 34-38)

• total length depends on wheel position and footrest position

• frame length with UNITOMIC L+3cm

• from 4° camber possible

### Junior2 AR

Active children wheelchair made of aluminium, foldable, with **detachable footrest** (without swing away footrest and side guard)

frame straight

SD 26 - 34 frame middle \*\*  
SD 36 - 38 frame long

Code 599

6cm abduction frame\*

SD 26 - 34 frame short \*\*  
SD 36 - 38 frame long \*\*\*

Code 598

**Basic price 2720,- €**

frame length with FB holder

**frame straight**      **abduction frame**

54cm = middle (SD 26-34)      52cm = short (SD 26-34)  
58cm = standard (SD 36/38)      56cm = long (SD 36/38)

• total length depends on wheel position and footrest position

• frame length with UNITOMIC L+3cm

• from 4° camber possible

\*\* Note: frame short only with 4°/5° and 20°/22° possible

\*\*\* Note: frame with 24° not possible!!!!

basic measures			
<p><b>Seat width (SW)</b></p> <div style="display: flex; justify-content: space-around;"> <div><input type="checkbox"/> 24*</div> <div><input type="checkbox"/> 26*</div> <div><input type="checkbox"/> 28</div> <div><input type="checkbox"/> 30</div> </div> <div style="display: flex; justify-content: space-around; margin-top: 10px;"> <div><input type="checkbox"/> 32</div> <div><input type="checkbox"/> 34</div> <div><input type="checkbox"/> 36</div> </div> <p style="font-size: small;">* frame straight CODE 221 not possible (only with abduction frame CODE 222)</p>	<p><b>Seat depth (SD)</b></p> <div style="display: flex; justify-content: space-around;"> <div><input type="checkbox"/> 26</div> <div><input type="checkbox"/> 28</div> <div><input type="checkbox"/> 30</div> <div><input type="checkbox"/> 32</div> </div> <div style="display: flex; justify-content: space-around; margin-top: 10px;"> <div><input type="checkbox"/> 34</div> <div><input type="checkbox"/> 36</div> <div><input type="checkbox"/> 38</div> </div> <p style="font-size: small;">please note details for frame short and long !!</p>	<p><b>back height (BH)</b></p> <div style="display: flex; justify-content: space-around;"> <div><input type="checkbox"/> 25</div> <div><input type="checkbox"/> 30</div> </div> <div style="display: flex; justify-content: space-around; margin-top: 10px;"> <div><input type="checkbox"/> 35</div> <div><input type="checkbox"/> 40</div> </div> <p style="font-size: small;">(+2,5cm adjustable)</p>	<p><b>Low Leg Length (LLL):</b></p> <p>LLL: ..... cm (regarding seat upholstery without seat cushion)</p> <p>min. 12 cm (without cushion) max. 45 cm max. LLL = SH - 3cm</p> <p style="font-size: x-small;">technical data see back side</p>

### note

**Seat height in cm**  
see possible wheel combination on page 2  
(without seat cushion)

front: \_\_\_\_\_ cm  
(Standard = 48/49cm)

back: \_\_\_\_\_ cm  
(Standard = 45/46cm)

Technical changes and print mistakes reserved.

Note: more measurements in special constructions possible !!

VD2359E-41

## Technical data

### seat width **SW**

from outside crossbar to outside crossbar +6mm

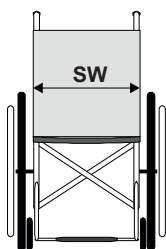

### seat depth **SD**

from back tube to upper edge seat upholstery

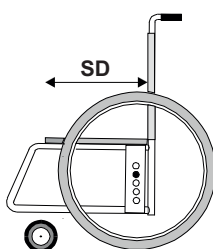

### back height **RH**

from upper edge seat upholstery to upper edge back upholstery

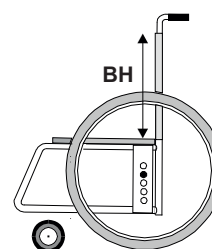

### Lower Leg Length LLL:

### Total width wheelchair:

with wheels and handrim  
with drum brake

### folding measurement:

with wheels  
with drum brake  
without wheels

### maximum burden:

15 to 49 cm

SW + 18 cm  
SW + 20 cm

about 30cm  
about 32cm  
about 22cm

120 kg

### seat height **SH**





















## Junior 2















Real wheel	Castor fork	minimum seat height		maximum seat height	
		front	back	front	back
20 inch	4 inch - short	44 cm	36 cm*	46 cm	46 cm
	5 inch - short	44 cm	36 cm*	47 cm	46 cm
	6 inch - short	45 cm	36 cm*	48 cm	46 cm
	140 mm - wide	46 cm	36 cm*	50 cm	46 cm
22 inch	4 inch - short - long	43 cm 46 cm	39 cm* 39 cm*	46 cm 50 cm	46 cm 49 cm
	5 inch - short - lang	44 cm 46 cm	39 cm* 39 cm*	47 cm 51 cm	46 cm 49 cm
	6 inch - short - long	45 cm 48 cm	39 cm* 39 cm*	48 cm 52 cm	48 cm 51 cm
	140 mm - wide	46 cm	39 cm*	50 cm	49 cm
24 inch	4 inch - short - long	44 cm 46 cm	43 cm* 43 cm*	46 cm 50 cm	46 cm 49 cm
	5 inch - short - long	44 cm 47 cm	43 cm* 43 cm*	47 cm 51 cm	46 cm 50 cm
	6 inch - short - long	45 cm 48 cm	43 cm* 43 cm*	48 cm 52 cm	46 cm 51 cm
	140mm - wide	46 cm	43 cm*	50 cm	49 cm









All measurements ± 0,5 cm



\*Advice: with drum brake you have to add 2cm!!

Notice: at the castor wheels **PU-black** are the minimal seat height with the fork **short** and **extra short** not possible

frame colour		Because of the material are different colours possible					
shiny	<input type="checkbox"/>  25 RAL9010 white	<input type="checkbox"/>  06 dormant red	<input type="checkbox"/>  44 RAL5015 sky blue met.	<input type="checkbox"/>  51 apple green metallic			
	<input type="checkbox"/>  56 RAL1021 gold yellow met.	<input type="checkbox"/>  40 red metallic	<input type="checkbox"/>  16 RAL5002 ultramarine blue	<input type="checkbox"/>  45 RAL6018 yellow green			
	<input type="checkbox"/>  24 RAL1028 melon yellow	<input type="checkbox"/>  43 RAL4010 telemagenta met.	<input type="checkbox"/>  17 dormant blue	<input type="checkbox"/>  60 mojit green met.			
	<input type="checkbox"/>  27 mandarin met.	<input type="checkbox"/>  53 cassis	<input type="checkbox"/>  64 petrol green met.	<input type="checkbox"/>  19 silver metallic			
	<input type="checkbox"/>  41 RAL3020 trafficed red met.	<input type="checkbox"/>  59 atlantic blue met.	<input type="checkbox"/>  50 apple green	<input type="checkbox"/>  23 RAL9005 black	met. = metalized		

frame colour		Because of the material are different colours possible					
mat / satined	<input type="checkbox"/>  76 white satined	<input type="checkbox"/>  69 purpur met. satined	<input type="checkbox"/>  75 petrol green met. satined				
	<input type="checkbox"/>  65 gold yellow met. satined	<input type="checkbox"/>  61 cool mint mat	<input type="checkbox"/>  73 yellow green met. satined				
	<input type="checkbox"/>  66 mandarin met. satined	<input type="checkbox"/>  72 sky blue met. satined	<input type="checkbox"/>  74 mojit green met. satined				
	<input type="checkbox"/>  67 traffic red satined	<input type="checkbox"/>  71 atlantic blue met. satined	<input type="checkbox"/>  77 silver metallic satined				
	<input type="checkbox"/>  68 telemagenta met. satined	<input type="checkbox"/>  70 ultramarine blue satined	<input type="checkbox"/>  22 RAL9011 black mat	met. = metalized			

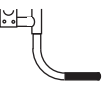
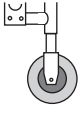

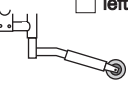
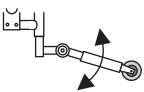

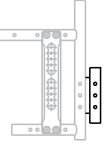



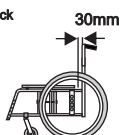
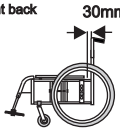
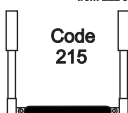
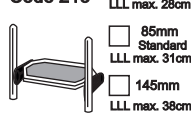
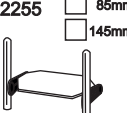
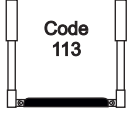
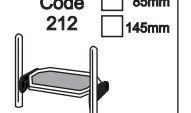
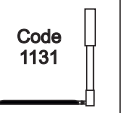
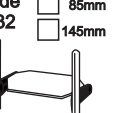
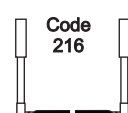
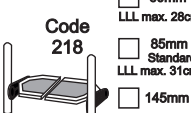
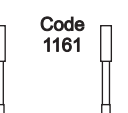

upholstery colours				
upholstery standard	<input type="checkbox"/>  DE290 black	upholstery breathable fabric	<input type="checkbox"/>  AG410 yellow	<input type="checkbox"/>  AG451 king blue
	<input type="checkbox"/>  AG430 red		<input type="checkbox"/>  AG460 lemon	
	<input type="checkbox"/>  AG441 pink		<input type="checkbox"/>  AG470 grey	
	<input type="checkbox"/>  AG450 ultramarine		<input type="checkbox"/>  AG490 black	
	<small>only for adjustable back upholstery</small>			
Code 201		OE 68,- €		

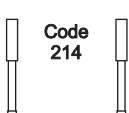
frame accessories					
<b>Tip shackle</b> <input type="checkbox"/> right <input type="checkbox"/> left  Code 105	<b>Transit wheels</b>  Code 102	<b>Walking stick holder, aluminium, with a loop for 2 crutches</b> <input type="checkbox"/> right <input type="checkbox"/> left  Code 103	<b>Anti-tip wheel</b> <input type="checkbox"/> right <input type="checkbox"/> left  Code 104	<b>Anti-tip wheel high adjustable and with gear segment</b> <input type="checkbox"/> right <input type="checkbox"/> left  Code 2405	
<input type="checkbox"/> Piece 74,- €	<input type="checkbox"/> Pair 248,- €	<input type="checkbox"/> Piece 87,- €	<input type="checkbox"/> Piece 148,- €	<input type="checkbox"/> Piece 188,- €	

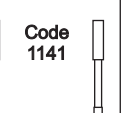
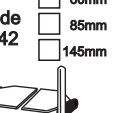
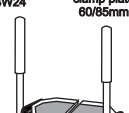
frame accessories	
<b>Adapter for frame attachments if a 3rd or 4th attachment part is required</b>  Code 104A <input type="checkbox"/> 1 piece <input type="checkbox"/> 2 pieces max. 2 adapter possible	
84,- € each	

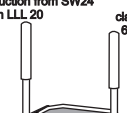
Technical changes and print mistakes reserved.

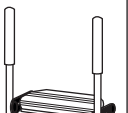
VD2359E-41

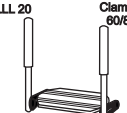
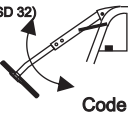
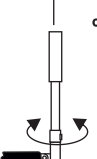
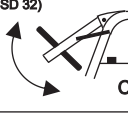
Junior2 <sub>SLT</sub> frame				Junior2 <sub>AR</sub> frame			
<p>Frame part +30mm backwards only for straight back</p>  <p>Code 204</p> <p>back tube 30mm displaced backwards (e.g. for straight back with back shell)</p>	<p>Spasticity frame back frame by street (reinforced version)</p> <p>recommended with strong spasticity</p> <p>Code 426</p>	<input type="checkbox"/> OE 120,- €	<input type="checkbox"/> OE 352,- €	<p>Frame part +30mm backwards only for straight back</p>  <p>Code 204</p> <p>back tube 30mm displaced backwards (e.g. for straight back with back shell)</p>	<p>Spasticity frame back frame by steel (reinforced version)</p> <p>recommended with strong spasticity</p> <p>Code 426</p>	<input type="checkbox"/> OE 120,- €	<input type="checkbox"/> OE 352,- €
footrest				footrest with holder			
<p>Single footrest alu-profile black, angle adjustable abduction frame short frame straight from LLL 33cm abduction frame long from LLL 38cm</p>  <p>Code 215</p>	<p>Single footrest alu-profile, mounted in frame frame straight from SW28 abduction from SW24 LLL 12 to 38</p> <p>clamp plate</p> <p>Code 213</p> <p><input type="checkbox"/> 60mm LLL max. 28cm <input type="checkbox"/> 85mm Standard LLL max. 31cm <input type="checkbox"/> 145mm LLL max. 38cm</p> 	<p>Single footrest, alu. flat-profile black abduction short frame straight from LLL 31cm abduction long from LLL 34cm</p> <p>Code 2253</p>	<p>Single footrest, alu. flat-profile, mounted in frame from LLL 12 to 35</p> <p>Code 2255</p> <p><input type="checkbox"/> 60mm <input type="checkbox"/> 85mm <input type="checkbox"/> 145mm</p> 	<p>Single footrest, alu-profile black, angle adjustable from LLL 33cm</p>  <p>Code 113</p>	<p>Single footrest alu-profile, mounted in frame, with holder, angle adjustment from LLL 12 to 38 from SW28</p> <p>Code 212</p> <p><input type="checkbox"/> 60mm <input type="checkbox"/> 85mm <input type="checkbox"/> 145mm</p> 	<p>Single footrest, alu. flat-profile, angle adjustment with holder from LLL 33</p>  <p>Code 1131</p>	<p>Single footrest, alu. flat-profile, mounted in frame with holder from LLL 12 to 35</p> <p>Code 1132</p> <p><input type="checkbox"/> 60mm <input type="checkbox"/> 85mm <input type="checkbox"/> 145mm</p> 
<input type="checkbox"/> Piece 302,- €	<input type="checkbox"/> Piece 320,- €	<input type="checkbox"/> Piece 302,- €	<input type="checkbox"/> Pc. 320,- €	<input type="checkbox"/> Piece 320,- €	<input type="checkbox"/> Piece 338,- €	<input type="checkbox"/> Pc. 320,- €	<input type="checkbox"/> Pc. 338,- €
<p>Double footrest, alu-profile black, angle adjustable. from LLL 33</p>  <p>Code 216</p>	<p>Double footrest alu-profile black, mounted in frame, angle adjustable frame straight from SW28 abduction from SW24 LLL 12 to 38</p> <p>clamp plate</p> <p>Code 218</p> <p><input type="checkbox"/> 60mm LLL max. 28cm <input type="checkbox"/> 85mm Standard LLL max. 31cm <input type="checkbox"/> 145mm LLL max. 38cm</p> 	<p>Double footrest, alu. flat-profile black, angle adjustable from LLL 33</p>  <p>Code 1161</p>	<p>Double footrest, alu. flat-profile, mounted in frame from LLL 12 to 35 from SW28 Abdu from SW24cm</p> <p>Code 1162</p> <p><input type="checkbox"/> 60mm <input type="checkbox"/> 85mm <input type="checkbox"/> 145mm</p> 	<p>Double footrest, alu profile black, angle adjustable with holder from LLL 33 from SW28</p>  <p>Code 214</p>	<p>Double footrest, alu-profile, mounted in frame, with holder from LLL 12 to 38 from SW28</p> <p>Code 211</p> <p><input type="checkbox"/> 60mm <input type="checkbox"/> 85mm <input type="checkbox"/> 145mm</p> 	<p>Double footrest, alu. flat-profile, angle adjustable with holder from LLL 33 from SW28</p>  <p>Code 1141</p>	<p>Double footrest, alu. flat-profile, mounted in frame from LLL 12 to 35 from SW28 Abdu from SW24cm</p> <p>Code 1142</p> <p><input type="checkbox"/> 60mm <input type="checkbox"/> 85mm <input type="checkbox"/> 145mm</p> 
<input type="checkbox"/> Pair 332,- €	<input type="checkbox"/> Pair 350,- €	<input type="checkbox"/> Pair 332,- €	<input type="checkbox"/> Pair 350,- €	<input type="checkbox"/> Pair 350,- €	<input type="checkbox"/> Pair 368,- €	<input type="checkbox"/> Pair 350,- €	<input type="checkbox"/> Pair 368,- €
<p>Double footrest alu-profile displaced with footrest bracket and clamp plate, angle adjustable frame straight from SW28 abduction from SW24 from LLL 20</p>  <p>Code 2246</p>	<p>Single footrest, alu-profile displaced with footrest bracket and clamp plate frame straight from SW28 abduction from SW24 from LLL 20</p> <p>clamp plate 60/85mm</p>  <p>Code 2247</p>	<p>Double footrest alu-profile displaced with footrest bracket and clamp plate, angle adjustable frame straight from SW28 abduction from SW24 from LLL 20</p> <p>clamp plate 60/85mm</p>  <p>Code 210</p>	<p>Single footrest, alu profile, displaced with footrest bracket and clamp plate, angle adjustable frame straight from SW28 abduction from SW24 from LLL 20</p> <p>clamp plate 60/85mm</p>  <p>Code 517</p>				
<input type="checkbox"/> Piece 368,- €	<input type="checkbox"/> Piece 346,- €	<input type="checkbox"/> Pair 385,- €	<input type="checkbox"/> Piece 362,- €				
<p>Double footrest flat profile displaced with footrest bracket and clamp plate, angle adjustable frame straight from SW28 abduction from SW24 from LLL 20</p> <p>Clamp plate 60/85mm</p>  <p>Code 1167</p>	<p>Single footrest flat profile displaced with footrest bracket and clamp plate angle adjustable frame straight from SW28 abduction from SW24 from LLL 20</p> <p>Clamp plate 60/85mm</p>  <p>Code 2257</p>	<p>Double footrest flat profile displaced with footrest bracket and clamp plate, angle adjustable frame straight from SW28 abduction from SW24 from LLL 20</p> <p>Clamp plate 60/85mm</p>  <p>Code 5172</p>	<p>Single footrest flat profile displaced with footrest bracket and clamp plate angle adjustable frame straight from SW28 abduction from SW24 from LLL 20</p> <p>Clamp plate 60/85mm</p>  <p>Code 5171</p>	<p>Elevating footrest with double footplate alu-profile angle adjustable and calf pads from SW 34 at straight frame from SW 28 at abduction frame from LLL 33/34 (from SD 32)</p>  <p>Code 226</p>			
<input type="checkbox"/> Piece 368,- €	<input type="checkbox"/> Piece 346,- €	<input type="checkbox"/> Piece 385,- €	<input type="checkbox"/> Piece 362,- €	<input type="checkbox"/> Pair 582,- €			
<p>Mechanism for swing away single footrest (footrest single to swing away outside)</p> <p>only in combination with single footrest from LLL 38cm</p>  <p>Code 418</p>	<p>Spasticity locking for single footrest</p> <p>footrest alu-profile</p> <p>Code 122</p> <p>footrest alu. flat-profile</p> <p>Code 1122</p> <p>Code 418A</p>	<p>Footrest (alu-profile) coloured like the frame colour *</p> <p>colour: _____</p> <p>Code 417</p> <p>(see frame colour on page 3)</p>	<p>Spasticity locking for double footrest</p> <p>footrest alu-profile</p> <p>Code 123</p> <p>footrest alu. flat-profile</p> <p>Code 1123</p>	<p>Elevating footrest with double footplate alu-profile / in frame, angle adjustable and calf pads from SW 34 by frame straight from SW 28 by abduction frame from LLL 22 / 23 cm (from SD 32)</p> <p>Clamp plate 60 / 85mm</p>  <p>Code 217</p>			
<input type="checkbox"/> Piece OE 178,- €	<input type="checkbox"/> Pc. OE 195,- €	<input type="checkbox"/> Piece OE 89,- €	<input type="checkbox"/> OE 68,- €	<input type="checkbox"/> Pair OE 154,- €	<input type="checkbox"/> Pair 620,- €		

Technical changes and print mistakes reserved.

VD2359E-41

## Height of push handles

Height of push handles for companion = Back height + Seat height + Height of push handle

**Height of push handles for companion = BH + SH + HPH**

Back standard



Back with height adjustable push handle

15cm normal

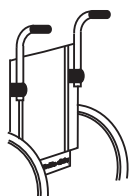

35cm long

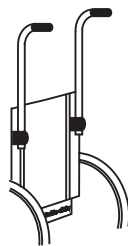

45cm extra long reinforced

cropped

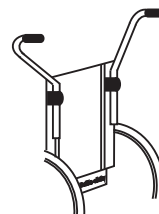

bent rewards

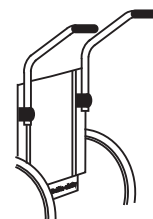

HPH

min.

max.

3cm

4cm

19cm

4cm

39cm

4cm

49cm

21cm

38cm

push handle  
each side 6cm  
outside



12cm

29cm



push handle  
each side 9cm  
backwards

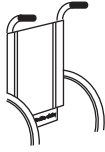
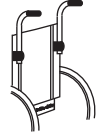

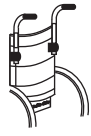
Technical changes and print mistakes reserved.

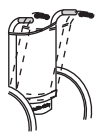
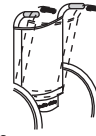
VD2359E-41

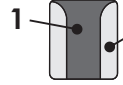
back									
<b>back standard (standard handles)</b>  <input type="checkbox"/> Code 107	<b>Back with handles height adjustable</b> <input type="checkbox"/> 15cm (standard) <input type="checkbox"/> 35cm (long) <input type="checkbox"/> offset outward <input type="checkbox"/> bent backwards  Code 108	<b>Back with adjustable upholstery</b>  Code 208	<b>Back with adjustable upholstery and height adjustable handles</b> <input type="checkbox"/> 15cm (standard) <input type="checkbox"/> 35cm (long) <input type="checkbox"/> cropped <input type="checkbox"/> bent rewards  Code 209	<b>Push handles extra long 45cm</b> the push handles are reinforced  Code 2205L  only in combination with Code 108 or Code 209	<b>without back upholstery</b>  Code 507 only in combination with Code 107 or 108				
<b>Standard</b>	Piece	OE 266,- €	<input type="checkbox"/> Piece	OE 262,- €	Piece	OE 518,- €	<input type="checkbox"/> OE 186,- €	<input type="checkbox"/> Piece	-

30°-back not approved for transport in the handicapped transport car				back	
<b>Gear segment for back angle adjustment for straight back</b> from BH 35  Code 407  Note: the combination with CODE 108 or CODE 209 is restricted possible!	<b>Back 30° angle adjustable (stabilization bar and anti tip wheel recommended)</b> <b>with gas spring (infinitely variable)</b>  from BH 30 Code 135	<b>mechanical adjustable with quick release lever (0°, 10°, 20°, 30°)</b>  from BH 30 Code 136	In combination with CODE 108 or 209: - from BH 35 - only with push handles 15cm (standard)		
<input type="checkbox"/> Piece	OE 210,- €	<input type="checkbox"/> Piece	MP 498,- €	<input type="checkbox"/> Piece	OE 398,- €

back system MATRIX		back	
light weight back cushion, breathable with individual adjustable holder and SlimLine-Design  <b>back MATRIX-Aktiv</b> with 7cm contour depth from SW 32 Code: <b>Aktiv</b> <input type="checkbox"/> <input type="checkbox"/> head rest aktive <input type="checkbox"/> side pads straight <input type="checkbox"/> side guard offset inwards Code: <b>Aktiv-K</b> <b>SPG</b> <b>SPA</b>	<b>SlimLine-Design for adjustable back upholstery with breathable fabric (AG410, 430, 441, 450, 451,460, 470 and 490)</b>  colour 1 (inside): black fabric 490 colour 2 (outside):  biocoloured upholstery  <input type="checkbox"/> Code 202		
Take prices and further information from respective MATRIX order form		OE 86,- €	

back			* Attention: with UNITOMIC back choose seat depth 2cm shorter
<b>Back UNITOMIC * with adjustable upholstery (anatomical back)</b> from BH35  Information: Choose seat depth 2cm shorter Code 206	<b>Back UNITOMIC * with adjustable back and height adjustable handles</b> from BH35  Information: Choose seat depth 2cm shorter Code 207	<b>Gear segment for back angle adjustment for UNITOMIC back</b> from BH40  Information: only in combination with CODE 410 or 412 possible! Code 411	
<input type="checkbox"/> Piece	OE 356,- €	<input type="checkbox"/> Piece	OE 586,- €
<input type="checkbox"/> Piece	OE 210,- €		



back			
<b>FIDIBUS back with clips</b> ergonomic back unit with clips extrem light ergonomic formed back standard: SW 28 - 40cm / BH 20 - 40cm  curved back 30mm (standard) <input type="checkbox"/> Code 2292F curved back 50mm <input type="checkbox"/> Code 2292F-5 Please take prices and further information from FIDIBUS order form	<b>FIDIBUS ASR back with clips</b> ergonomic shaped back plate ASR alu back plate coloured, curved and beveled (without cushion) colour: frame colour 30mm curved back (standard) <input type="checkbox"/> CODE 2294F 50mm curved back <input type="checkbox"/> 2294F-5	ergonomic shaped back cushion ASR back cushion (foam) with cover (without back plate) 30mm curved back (standard) <input type="checkbox"/> CODE 2296A 50mm curved back <input type="checkbox"/> 2296A-5	<b>FIDIBUS ASR back lockable</b> anatomical shaped back plate ASR lockable Alu-back plate coloured, curved an beveled (without cushion) colour: frame colour from BH 30cm 30mm curved back (standard) <input type="checkbox"/> CODE 2294FV 50mm curved back <input type="checkbox"/> 2294FV-5 only with Code 108 or 110 possible!
Piece	OE 634,- €	Piece	OE 432,- €
		Piece	OE 369,- €
		Piece	OE 632,- €
		Piece	OE 372,- €

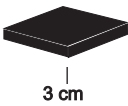

Technical changes and print mistakes reserved.

VD2359E-41

Note: when using SlimLine-Design (Code 202) the seat cushion (Code 470 / 471 / 472) is also supplied in SlimLine-Design.

seat						
Cushion, compounded with black cover  Code 119 <input type="checkbox"/> Code 120 <input type="checkbox"/>	Cushion compounded with breathable cover ... Code 471 <input type="checkbox"/> Code 472 <input type="checkbox"/>	Change cover Cover black <input type="checkbox"/> Code 121 Cover breathable... <input type="checkbox"/> Code 470	Seat belt black Plastic closure Code 227 <input type="checkbox"/> Piece 78,- € Metal closure Code 125	Seat belt with pad, black 2-point pelvic restraint belt with metal closure Code 124	Seat belt with pad, black 4-point pelvic restraint belt with metal closure Code 124-4	without seat upholstery Code 502
Piece 112,- €		Piece 76,- €	<input type="checkbox"/> Piece 88,- €	<input type="checkbox"/> Stück 172,- €	<input type="checkbox"/> Stück 213,- €	<input type="checkbox"/> Piece 0,- €

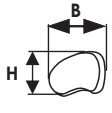
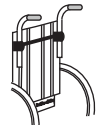
seat			Seat cushion by wheelchair with back upholstery	Seat cushion by wheelchair with MATRIX- or FIDIBUS back
Alu-Seat plate for cross bar Code 277 <input type="checkbox"/> Piece 192,- €	Alu-Seat plate with safty pin for cross bar Code 278 <input type="checkbox"/> Piece 250,- €	Alu-Seat plate with plastic clips for cross bar Code 279 <input type="checkbox"/> Piece 229,- €	<b>FIDIBUS-F</b> ergonomic seat cushion straight at the back extrem light ergonomic formed seat cushion from SW 24 from SD 26  Code 2291F Please take prices and further Informations from the FIDIBUS oder form <input type="checkbox"/> Piece OE 574,- €	<b>FIDIBUS</b> ergonomic seat cushion extrem light ergonomic formed seat cushion from SW 24 from SD 26  Code 2291 Please take prices and further Informations from the FIDIBUS oder form <input type="checkbox"/> Piece OE 574,- €

accessories						
Measurements headrest  H B mini 12cm 20cm medium 15cm 28cm big 18cm 34cm	headrest standard imitation leather MM190 black with standard-back for back with CODE 107 and 208 with height adjustable push handles for back with CODE 108, 209 and 207 Größe: <input type="checkbox"/> mini <input type="checkbox"/> medium <input type="checkbox"/> big Code 224 piece 325,- €	Holder for headrest for height adjustable push handles for back with CODE 108, 209 and 207 for headrest tube: <input type="checkbox"/> 15x15mm Code 225V <input type="checkbox"/> Ø 19mm Code 225R piece 208,- €	headrest "light" aluminium Ø19mm AG490 black breathable fabric for standard back für Rücken mit CODE 107 u. 208 for height adjustable push handles for back CODE 108, 209 a. 207 size: <input type="checkbox"/> mini <input type="checkbox"/> medium Code 3524 piece 328,- €	Positioning aid for headrest „light“ Code 3526 <input type="checkbox"/> piece 60,- €	stabilisation tube only for height adjustable push handles from BH 30  Code 178 <input type="checkbox"/> piece 158,- €	stabilisation tube at the push handles = push bar  Code 478 <input type="checkbox"/> piece 172,- €

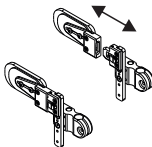
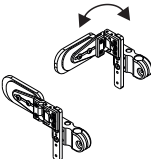

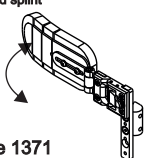
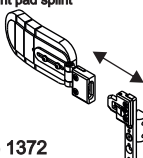
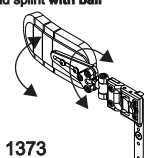
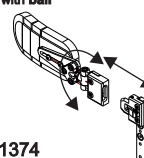
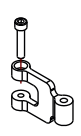
accessories		
Side pads pluggable mounted at push handle holder long  Code 137S (only in combination with back CODE 108 or 110) <input type="checkbox"/> Pair 426,- €	Side pads removable mounted at push handle holder long  Code 137A (only in combination with back CODE 108 or 110) <input type="checkbox"/> Pair 426,- €	

side pads					
side pads narrow shape angle-adjustable with joint element mounted on the spacer with bar Cover black MM190 size side pads <input type="checkbox"/> size S D=12cm H=6cm <input type="checkbox"/> size M D=15cm H=7cm <input type="checkbox"/> size L D=18cm H=8cm <input type="checkbox"/> size XL D=20,5cm H=10cm W = SB-2,5cm W = width between the side pads Code 1371 <input type="checkbox"/> Pair 592,- €	side pads foldable with straight pad splint mounted at push handle holder Joint side pad holder flat foldable, with connecting joint and with straight pad splint  Code 1371 <input type="checkbox"/> Pair 592,- €	side pads foldable with straight pad splint mounted at push handle holder Plug-in connection side pad holder flat, with connection joint and with straight pad splint  Code 1372 <input type="checkbox"/> Pair 592,- €	side pads foldable with ball joint element mounted at push handle holder Joint side pad holder flat foldable, with connecting joint and with straight pad splint with ball  Code 1373 <input type="checkbox"/> Pair 688,- €	side pads pluggable with ball joint element mounted at push handle holder Plug-in connection side pad holder flat, with connection joint and with pad splint with ball  Code 1374 <input type="checkbox"/> Pair 688,- €	additional set of joint elements 2 additional joint elements for side pads (right and left)  Code 1379 <input type="checkbox"/> Pair 128,- €

Technical changes and print mistakes reserved.

VD2359E-41

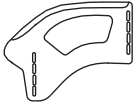
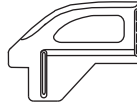
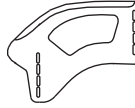
side guard

<p>Clothing guard round screwed on, <b>aluminium</b> with cold protection (in frame colour)</p>  <p>Code 433</p>	<p>Clothing guard screwed on, <b>plastic black</b></p>  <p>Code 430</p>	<p>Clothing guard round <b>PC-Carbon</b> screwed on (CARBON-optic)</p>  <p>Code 230</p>	<p>Clothing side guard <b>ERGO AL</b> aluminium with cold protection, screwed on (in frame colour)</p>  <p>Code 437</p>	
<input type="checkbox"/> Pair 288,- €	<input type="checkbox"/> Pair 230,- €	<input type="checkbox"/> Pair 276,- €	<input type="checkbox"/> Pair 296,- €	

side guard

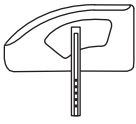
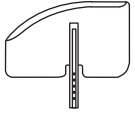
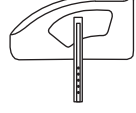
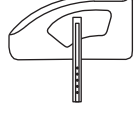
<p>Clothing guard round pluggable, <b>aluminium</b> with cold protection (in frame colour)</p>  <p>Code 434</p>	<p>Clothing guard pluggable, <b>plastic black</b></p>  <p>Code 431</p>	<p>Clothing guard round pluggable, <b>PC Carbon</b></p> <p>normal wheel overlap 45mm</p>  <p>Code 525</p>	<p>wide wheel overlap 60mm</p>  <p>Code 525B</p>	
<input type="checkbox"/> Pair 352,- €	<input type="checkbox"/> Pair 318,- €	<input type="checkbox"/> Pair 344,- €	<input type="checkbox"/> Pair 412,- €	

side guard

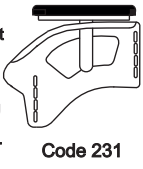
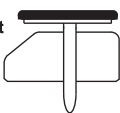
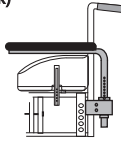
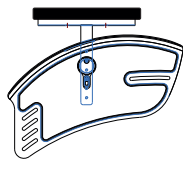
<p>Clothing guard round aluminium with cold protection and armrest short (in frame colour)</p> <p><input type="checkbox"/> armrest short Code 231</p> <p><input type="checkbox"/> armrest long Code 231L</p>  <p>Code 231</p>	<p>Side guard plastic, black detachable / pluggable with armrest</p> <p><input type="checkbox"/> armrest long</p> <p><input type="checkbox"/> armrest short</p>  <p>Code 236</p>	<p>Armrest swingable to side and height adjustable Combination only with clothing guard pluggable/screwed on (not possible with 30° back)</p> <p><input type="checkbox"/> armrest short</p> <p><input type="checkbox"/> armrest long</p>  <p>Code 432 (without clothing guard)</p>	<p>Clothing guard <b>ERGO AL</b> aluminium with armrest short screwed on and with cold protection (in frame colour)</p> <p>armrest short</p>  <p>Code 4371</p>	
Pair 335,- €	Pair 329,- €	Pair 279,- €	<input type="checkbox"/> Pair 364,- €	

side guard

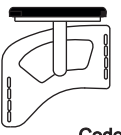
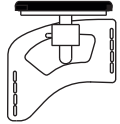
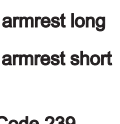
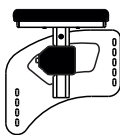
<p>Side guard, screwed on aluminium with cold protection</p>  <p>Code 232</p>	<p>Side guard, screwed on with armrest short and with cold protection</p>  <p>Code 238</p>	<p>Side guard screwed on with armrest height adjustable</p> <p>Standard type (for capacity up to 50kg) armrest with rail</p> <p><input type="checkbox"/> armrest long</p> <p><input type="checkbox"/> armrest short</p> <p>Code 233</p> 	<p>Strong type (for capacity up to 100kg) armrest holder with type profile</p> <p><input type="checkbox"/> armrest long</p> <p><input type="checkbox"/> armrest short</p> <p>Code 239</p> 	<p>Side guard aluminium screwed on with height adjustable armrest (with raster RACY)</p> <p>armrest holder with raster</p> <p><input type="checkbox"/> armrest long</p> <p><input type="checkbox"/> armrest short</p> <p>Code 235</p> 	
<input type="checkbox"/> Pair 240,- €	<input type="checkbox"/> Pair 286,- €	Pair 348,- €	pair 364,- €		

therapy tray

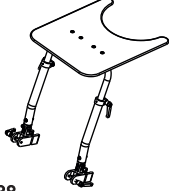
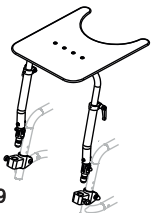
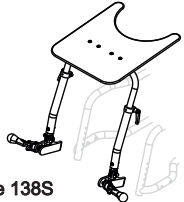
<p>Therapy tray swing away (only in combination with armrest long)</p>  <p><input type="checkbox"/> right mounted (standard)</p> <p><input type="checkbox"/> left mounted</p> <p>Code 134</p>	<p>Therapy tray mounted on the frame with clamp attachment on the frame</p>  <p>Code 138</p>	<p>Therapy tray <b>plug</b> on the frame with plug attachment on the frame</p>  <p>Code 139</p>	<p>Therapy tray on the frame quick release clamped (at the frame)</p>  <p>Code 138S</p>	
Piece 308,- €	<input type="checkbox"/> Piece 478,- €	<input type="checkbox"/> Piece 478,- €	<input type="checkbox"/> Piece 502,- €	

Technical changes and print mistakes reserved.

VD2359E-41

### Combinationen wheels with frame length

Rear wheel	Frame straight (integrated) <b>CODE 221</b>	Frame with abduction (integrated) <b>CODE 222</b>	Frame straight (with detachable footrest) <b>CODE 599</b>	Frame with abduction (with detachable footrest) <b>CODE 598</b>
20"	possible	possible	possible	possible
22"	possible	possible	possible	only with 4" / 5" possible
24"	possible	possible	frame (short) middle not possible frame long possible	<b>not possible*</b>

\* only possible:  
only by castor position „C“,  
only with Pull-to-Lock-brake  
only with 24x1" pneumatic  
mind. 4" Chamber  
with brake holder „H“  
(with anchor plate system not possible!)

### Wheel plate:

Center of gravity adjustment (measured from back tube to wheel center)

Wheel plate standard / back straight:

A = 6,0 cm

B = 4,0 cm

C = 2,0 cm

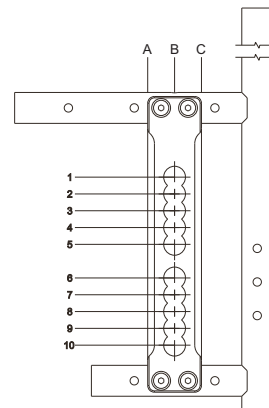

Wheel plate standard / UNITOMIC back:

A = 6,0 cm (2,5cm at bow)

B = 4,0 cm (0,5cm at bow)

C = 2,0 cm (-1,5cm at bow)

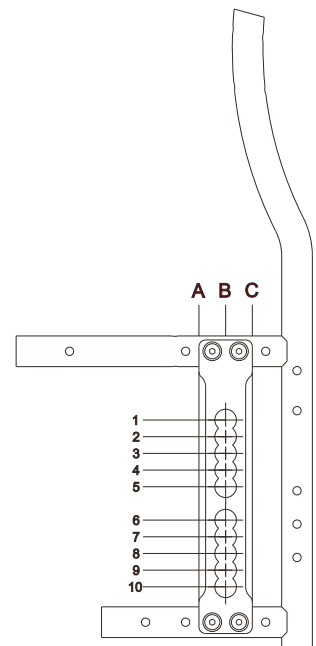

Technical changes and print mistakes reserved.

VD2359E-41

\* Note to the 24" rear wheels:  
frame CODE 221 and frame CODE 222 is possible  
frame CODE 589 only possible in combination with frame long  
frame CODE 589 is not possible !!!

rear wheel standard

<b>Rear wheel standard (Alu hub black) with quick release axle pneumatic</b> <input type="checkbox"/> 20"x1* fine profile Code 142 <input type="checkbox"/> 20"x1 black fine profile Code 142S <input type="checkbox"/> 22"x1 3/8* rough profile Code 150 <input type="checkbox"/> 22"x1* fine profile Code 144 <input type="checkbox"/> 22"x1 black fine profile Code 144S <input type="checkbox"/> 24"x1 3/8* rough profile Code 151 <input type="checkbox"/> 24"x1* fine profile Code 157 <input type="checkbox"/> 24"x1 black fine profile Code 157S		<b>Design rear wheel 24" (Alu hub silver) with quick release axle, straight spoke wheel</b> <input type="checkbox"/> 20"x1 Code 240 <input type="checkbox"/> 20"x1 black Code 241 <input type="checkbox"/> 22"x1 3/8 grey Code 149 <input type="checkbox"/> 22"x1 grey Code 141 <input type="checkbox"/> 22"x1 black Code 141S <input type="checkbox"/> 24"x1 3/8 grey Code 153 <input type="checkbox"/> 24"x1 grey Code 154 <input type="checkbox"/> 24"x1 black Code 154S		<b>Performance tyre</b> <input type="checkbox"/> 24"x1 Code 570 <small>Marathon Plus (grey tyre)</small> <input type="checkbox"/> 22"x1 Code 577 <small>Marathon Plus Evolution (black tyre)</small> <input type="checkbox"/> 24"x1 Code 572 <small>Marathon Plus Evolution (black tyre)</small>		<b>Right Run</b> <b>24"x1</b> Code 573 <input type="checkbox"/> red <input type="checkbox"/> blue <input type="checkbox"/> grey <input type="checkbox"/> black <b>22"x1</b> Code 576 <input type="checkbox"/> black		<b>Camber</b> 0° <input type="checkbox"/> 2° <input type="checkbox"/> 4° <input type="checkbox"/> <small>(standard)</small> 7° <input type="checkbox"/> 10° <input type="checkbox"/>	
* grey tyres		Standard		max. 7° camber		OE 40,- €			

handrim for rear wheel standard



<b>Handrim for rear wheel standard and Design rear wheel 24"</b> <b>aluminium black</b> <input type="checkbox"/> 20" Code 158 <input type="checkbox"/> 22" Code 455 <input type="checkbox"/> 24" Code 454 extension narrow <input type="checkbox"/> wide <input type="checkbox"/>					<b>Aluminium silver</b> <input type="checkbox"/> 22" Code 492 <input type="checkbox"/> 24" Code 491		<b>stainless less polished</b> <input type="checkbox"/> 20" Code 291 <input type="checkbox"/> 22" Code 155 <input type="checkbox"/> 24" Code 156		<b>TETRA-GRIP (Super Grip)</b> <input type="checkbox"/> 20 inch Code 254 <input type="checkbox"/> 22 inch Code 252 <input type="checkbox"/> 24 inch Code 452		<b>GEKKO S black anodized with rubber lip</b> <input type="checkbox"/> 22" Code 4501 <input type="checkbox"/> 24" Code 4508 Anbau <input type="checkbox"/> eng <input type="checkbox"/> weit		<b>GEKKO S black anodized with rubber lip Ø - smaller</b> <input type="checkbox"/> 22" Code 4503 <input type="checkbox"/> 24" Code 4507 <input type="checkbox"/> narrow <input type="checkbox"/> wide		<b>CURVE black anodized</b> CURVE <input type="checkbox"/> 22 inch Code 4502 CURVE L <input type="checkbox"/> 24 inch Code 4504		<b>Handrim cover black</b>  <input type="checkbox"/> 20 inch Code 290 <input type="checkbox"/> 22 inch Code 191 <input type="checkbox"/> 24 inch Code 192	
Standard					OE 322,- €		MP 506,- €		OE 506,- €		OE 392,- €		<input type="checkbox"/> Pair 138,- €					

rear wheel

<b>SAFETY-GRIP-rear wheel rim with integratd hand rim</b> <input type="checkbox"/> 22 inch Code 261 <input type="checkbox"/> 24 inch Code 461 only in combination with rear wheel or rear wheel with drum brake		<b>Rear wheel with drum brake and quick release axle (for companion)</b> <input type="checkbox"/> 20 inch Code 140 <input type="checkbox"/> 22 inch Code 160 <input type="checkbox"/> 24 inch Code 159 not in combinaiton with special rear wheel TENSIO, LWW or Design rear wheel		<b>"Black Edition"</b> Drum brake rear wheel with black rim, black hub and quick release axle with black cap and with tyre Marathon Plus Evolution (black tyre) 22"x1 or 24"x1 Code 2263 (only in combination with CODE 159 or 160)		Pair OE 104,- €		Pair OE 318,- €		<input type="checkbox"/> Pair OE 108,- €	
--	--	--	--	---	--	-----------------	--	-----------------	--	--	--

light weight wheel



one hand drive

<b>Light weight wheel LWW with black rim, 24 spokes black radialspeaks and black alu hand rim and pneumatic tyre (fine profile)</b> grey tyre Alu-handrim black anodized 20 x1" <input type="checkbox"/> CODE 565 22 x1" <input type="checkbox"/> CODE 564 24 x1" <input type="checkbox"/> CODE 563 Alu-handrim silver anodized CODE 565S CODE 564S CODE 563S black tyre hand rim black CODE 2868 CODE 2867 CODE 2866			<b>Handrim additional for the driven wheel</b> handrim in stainless steel Code 198Z (only in combination with one hand drive)		<b>One hand drive with quick release axle and stainless steel double handrim</b> # from SW 28cm # camber max. 5° Combination with drum brake is possible!! left distance handrim 22" <input type="checkbox"/> Code 193 normal <input type="checkbox"/> Code 2193 narrow 24" <input type="checkbox"/> Code 194 normal <input type="checkbox"/> Code 2194 narrow right distance handrim 22" <input type="checkbox"/> Code 195 normal <input type="checkbox"/> Code 2195 narrow 24" <input type="checkbox"/> Code 196 normal <input type="checkbox"/> Code 2196 narrow				gab / distance of double handrim normal  narrow  small distance for small hands	
Pair not possible with solid tyre 1 max. 7° camber OE 188,- €			<input type="checkbox"/> Pc. OE 145,- €		Pair OE 998,- €					

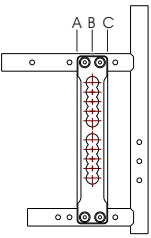
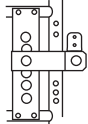
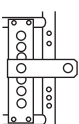
wheel plate for rear wheel

<b>Center of gravity adjustment</b> wheel position: 		<b>Wheel extension for drum brake</b>  Code 162 <input type="checkbox"/> Pair 204,- €		<b>Wheel extension</b>  Code 161 <input type="checkbox"/> Pair 158,- €	
---	--	---	--	--	--

rear wheel spoke cover

<p>spoke cover transparent</p>  <p><input type="checkbox"/> 20 inch Code 164 <input type="checkbox"/> 22 inch Code 165 <input type="checkbox"/> 24 inch Code 166</p>	<p>spoke cover with special-motive</p> <p>the price for special-spoke cover are net price and not discountable!</p> <p><a href="http://www.speichenschutz.com">www.speichenschutz.com</a></p> <p>Motiv-Nr.: _____ <input type="checkbox"/> 24" _____ <input type="checkbox"/> 22" _____ <input type="checkbox"/> 20"</p> <p>please take the motive no. from the website <a href="http://www.speichenschutz.com">www.speichenschutz.com</a></p> <p>Code 2268</p>	<p>Example</p>   <p>Information about others spoke cover motives please take website</p>
<p><input type="checkbox"/> Pair 180,- €</p>	<p><input type="checkbox"/> Pair net price 232,- €</p>	<p><input type="checkbox"/> Pair net price 220,- €</p>

Castor

<p>Castor with screw axle and Design-fork, black solid</p> <p><input type="checkbox"/> 4 inch Skater Code 589 <input type="checkbox"/> 4 inch grey Code 581 <input type="checkbox"/> 5 inch grey Code 582 <input type="checkbox"/> 5 inch black Code 582S</p>	<p><input type="checkbox"/> 6 inch grey Code 583 <input type="checkbox"/> 6 inch black Code 583S <input type="checkbox"/> 140mm soft grey Code 583-140 <input type="checkbox"/> 140mm soft black Code 583-145</p>	<p>PU tyre in black</p> <p>PU black</p> <p><input type="checkbox"/> 4 inch Code 5887 <input type="checkbox"/> 5 inch Code 5888 <input type="checkbox"/> 6 inch Code 5889</p>
<p>Castor pneumatic with srew axle and Design-fork, black pneumatic</p> <p><input type="checkbox"/> 6 inch grey Code 586</p>		

Standard

Castor

<p>Lightwheel castor with LED light</p> <p><input type="checkbox"/> 4 inch Code 181LED <input type="checkbox"/> 5 inch Code 582LED</p>	<p>Soft aluminium castor black tyre (solid) soft</p> <table border="0"> <tr> <td style="width: 50%;"> <p>aluminium rim silver</p> <p><input type="checkbox"/> 4 inch Code 5894 <input type="checkbox"/> 5 inch Code 5895</p> </td> <td style="width: 50%;"> <p>aluminium rim black</p> <p><input type="checkbox"/> 4 inch Code 5894S <input type="checkbox"/> 5 inch Code 5895S</p> </td> </tr> </table>	<p>aluminium rim silver</p> <p><input type="checkbox"/> 4 inch Code 5894 <input type="checkbox"/> 5 inch Code 5895</p>	<p>aluminium rim black</p> <p><input type="checkbox"/> 4 inch Code 5894S <input type="checkbox"/> 5 inch Code 5895S</p>	<p>Castor solid with plastic rim black and black tyre (slim tyre)</p> <p><input type="checkbox"/> 4 inch Code 580 <input type="checkbox"/> 5 inch Code 584</p>	<p>Soft castor plastic rim black tyre (solid) soft</p> <p>plastic rim black</p> <p><input type="checkbox"/> 5 inch Code 5885 <input type="checkbox"/> 6 inch Code 5886</p>
<p>aluminium rim silver</p> <p><input type="checkbox"/> 4 inch Code 5894 <input type="checkbox"/> 5 inch Code 5895</p>	<p>aluminium rim black</p> <p><input type="checkbox"/> 4 inch Code 5894S <input type="checkbox"/> 5 inch Code 5895S</p>				
<p>Pair OE 54,- €</p>	<p>Pair OE 102,- €</p>	<p>Pair OE 48,- €</p>	<p>Pair OE 66,- €</p>		

Castor



<p>Castor fork with quick release axle</p>  <p>Code 180</p>	<p>Quick release axle adjustment kit (only in black)</p> <table border="0"> <tr><td><input type="checkbox"/> 4" solid with castor fork short</td><td>Code 480</td></tr> <tr><td><input type="checkbox"/> 4" solid with castor fork long</td><td>Code 481</td></tr> <tr><td><input type="checkbox"/> 5" solid with castor fork short</td><td>Code 482</td></tr> <tr><td><input type="checkbox"/> 5" solid with castor fork long</td><td>Code 483</td></tr> <tr><td><input type="checkbox"/> 6" solid with castor fork short</td><td>Code 484</td></tr> <tr><td><input type="checkbox"/> 6" solid with castor fork long</td><td>Code 485</td></tr> <tr><td><input type="checkbox"/> 6" pneumatic with castor fork short</td><td>Code 486</td></tr> <tr><td><input type="checkbox"/> 6" pneumatic with castor fork long</td><td>Code 487</td></tr> <tr><td><input type="checkbox"/> 140mm soft with castor fork wide</td><td>Code 488</td></tr> </table>	<input type="checkbox"/> 4" solid with castor fork short	Code 480	<input type="checkbox"/> 4" solid with castor fork long	Code 481	<input type="checkbox"/> 5" solid with castor fork short	Code 482	<input type="checkbox"/> 5" solid with castor fork long	Code 483	<input type="checkbox"/> 6" solid with castor fork short	Code 484	<input type="checkbox"/> 6" solid with castor fork long	Code 485	<input type="checkbox"/> 6" pneumatic with castor fork short	Code 486	<input type="checkbox"/> 6" pneumatic with castor fork long	Code 487	<input type="checkbox"/> 140mm soft with castor fork wide	Code 488
<input type="checkbox"/> 4" solid with castor fork short	Code 480																		
<input type="checkbox"/> 4" solid with castor fork long	Code 481																		
<input type="checkbox"/> 5" solid with castor fork short	Code 482																		
<input type="checkbox"/> 5" solid with castor fork long	Code 483																		
<input type="checkbox"/> 6" solid with castor fork short	Code 484																		
<input type="checkbox"/> 6" solid with castor fork long	Code 485																		
<input type="checkbox"/> 6" pneumatic with castor fork short	Code 486																		
<input type="checkbox"/> 6" pneumatic with castor fork long	Code 487																		
<input type="checkbox"/> 140mm soft with castor fork wide	Code 488																		
<p><input type="checkbox"/> Pair OE 168,- €</p>	<p>Set only in combination with CODE 180 OE 288,- €</p>																		



Castor

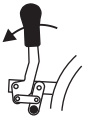

<p>Design fork coloured</p> <p>colour: _____</p> <p>Code 499</p> <p>(look at the frame colour on page 3)</p>	<p>Castor fork with "straight keeper"</p> <p>direction locking device for directional stability for 4", 5", 140mm or 6" wheel</p> <p>Code 281</p> <p>Note: castor with quick release not possible!</p>	<p>Castor fork with locking device (locking pin)</p> <p>direction locking device for directional stability for 4", 5", 140mm oder 6"-wheel</p> <p>Code 280</p> <p>Note: castor with quick release not possible!</p>
<p><input type="checkbox"/> Pair OE 98,- €</p>	<p><input type="checkbox"/> Pair OE 198,- €</p>	<p><input type="checkbox"/> Pair OE 219,- €</p>

Note to the castor: CODE 598 frame short: only with castor 4" or 5"

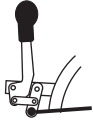
Technical changes and print mistakes reserved. VD2359E-41

brake				
<p>Knee angle brake offset with short lever stroke</p>  <p><input type="checkbox"/> Code 174K</p>	<p>Knee angle brake "Pull to lock"</p>  <p>pull to lock the brake</p> <p><input type="checkbox"/> Code 274</p>	<p>Brake lever extension straight foldaway</p>  <p>(only for CODE 174K)</p> <p>Code 175</p>	<p>One hand brake with brake lever extension</p> <p><input type="checkbox"/> right</p> <p><input type="checkbox"/> left</p> <p>Code 173</p>	
<b>Standard</b>		<input type="checkbox"/> Pair	84,- €	Piece OE 278,- €

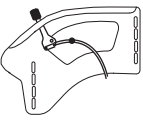
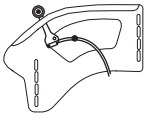
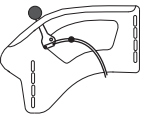
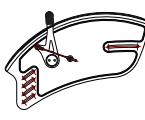
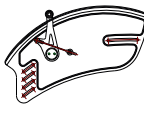
brake						
<p>Knee angle brake 174K switched through companion</p> <p>(combination with drum brake Code 140 / 159 / 160 and with Code 175 not possible)</p>  <p>Code 2478</p>	<p>additional knee angle brake only for companion, activated with bowden cable (alternative for drumbrake) (additional drum brake mounted under the frame)</p>  <p>Code 2479</p> <p>(combination with drum brake Code 140 / 159 / 160 and with Code 175 not possible)</p>		<p>Knee angle brake offset with locking pin for locking</p>  <p>fixed in the braked position</p> <p><input type="checkbox"/> Code 174Rast</p>	<p>fixed in the braked and opened position</p> <p><input type="checkbox"/> Code 174RastD</p>	<p>fixed in the opened position</p> <p><input type="checkbox"/> Code 174RastO</p>	
<input type="checkbox"/> Pair	OE 212,- €	<input type="checkbox"/> Pair	334,- €	OE 192,- €	OE 292,- €	OE 268,- €



brake					
<p>Knee angle brake integrated in side guard</p>			<p>Knee angle brake integrated in ERGO AL side guard</p>		
<p>with brake lever long cap (rubber)</p>  <p><input type="checkbox"/> Code 2289</p>	<p>with brake lever short hemisphere 2-piece screwed</p>  <p><input type="checkbox"/> Code 2289H</p>	<p>with brake lever curved ball Ø32mm screwed</p>  <p><input type="checkbox"/> Code 2289A</p>	<p>with brake lever long cap (rubber)</p>  <p><input type="checkbox"/> Code 2289E</p>	<p>with brake lever short hemisphere 2-piece screwed</p>  <p><input type="checkbox"/> Code 2289K</p>	<p>with brake lever curved ball Ø32mm screwed</p>  <p><input type="checkbox"/> Code 2289B</p>
<p>Pair only in combination with side guard CODE 433, 232 or 230</p>			<p>Pair only in combination with side guard ERGO AL CODE 437</p>		
OE 179,- €			OE 182,- €		



accessories	
<p><b>Anchor plate system</b></p> <p>anchor plates for transport in cars (ISO 7176-19)</p> <p>Assembly kit for wheelchairs including mounting</p>  <p>Code 2490</p>	<p>note for anchor plate system:</p> <p>Junior2 Ar / SLT: wheel plate in position C and anchor plate system is from 7° camber possible !!!</p> <p>Junior2 AR: Anchor plate system with frame abduction short (SD 26-34) is not possible !!!</p> <p>Junior 2 AR: with abduction frame from SD 36/38cm possible !!!</p> <p>Junior 2 AR: with frame straight possible!</p>
<input type="checkbox"/> Set	895,- €

note



Technical changes and print mistakes reserved.

VD2359E-41

Junior2 SLT		accessories	
<b>traking extension TRIKE as steering and pushing aid</b> hook closure 		<h1>Trike</h1> <p>traking extension as steering and pushing aid</p> 	
# holder lateral at frame (for type d.23) with hook closure # casotr 10x2" black alu fork # arrangement with gear segment # with ramp as mounting aid	# holder lateral at frame (for type d.23) with hook closure # casotr 10x2" black alu fork # arrangement with gear segment # with ramp as mounting aid	capacity up to <b>60kg</b> (wheelchair incl. payload) size 1: frame straight SW 26cm - 28cm frame abduction SW 24cm - 28cm size 2: seat width 30cm - 34cm <b>CODE 9901</b>	capacity up to <b>90kg</b> (wheelchair incl. payload) size 3: seat width 36cm - 40cm size 4: seat width 42cm - 46cm <b>CODE 9902</b>
<input type="checkbox"/> Piece 489,- €	<input type="checkbox"/> Piece 629,- €		

Junior2 AR		accessories	
<b>traking extension TRIKE as steering and pushing aid</b> hook closure 		<h1>Trike</h1> <p>traking extension as steering and pushing aid</p> 	
# special holder lateral at frame (for type d.23) with hook closure # castor 10x2" black alu fork # Gestänge mit Zahnsegment # mit Rampe als Montagehilfe	# special holder lateral at frame (for type d.23) with hook closure # castor 10x2" black alu fork # Gestänge mit Zahnsegment # mit Rampe als Montagehilfe	capacity up to <b>60kg</b> (wheelchair incl. payload) size 1: frame straight SW 28cm - 28cm frame abduction SW 24cm - 28cm size 2: seat width 30cm - 34cm <b>CODE 9906</b>	capacity up to <b>90kg</b> (wheelchair incl. payload) size 3: seat width 36cm - 40cm size 4: seat width 42cm - 46cm <b>CODE 9907</b>
<input type="checkbox"/> Piece 516,- €	<input type="checkbox"/> Piece 675,- €		

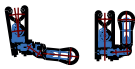
TRIKE colour frame Edition "...-Color"			
Note: the TRIKE frame parts are made of aluminium	TRIKE- frame colour powder coated  Colour : frame colour (see page 1)  - frame type right / left - cross tube - castor fork  <b>Code 9908</b>	Edition "Duo-Color"  colour 1: _____ (castor fork)  colour 2: _____ (frame type right / left, cross tube)  <b>Code 9909</b>	Castor fork with brake for directional stability          <b>Code 9909F</b>
	without extra charge <input type="checkbox"/> OE 136,- €	<input type="checkbox"/> OE 146,- €	<input type="checkbox"/> Piece OE 156,- €

Junior2 SLT		accessories	
<b>traking extension TRIKE as steering and pushing aid</b> quick release (clamp) 		<h1>Trike</h1> <p>traking extension as steering and pushing aid</p> 	
# holder quick release (clamp) at frame (for pipe Ø 23mm) # castor 10x2" black alu fork # arrangement of levers with gear segment # with ramp as mounting aid # with adjusting ring at frame (Ø 23mm)	# holder quick release (clamp) at frame (for pipe Ø 23mm) # castor 10x2" black alu fork # arrangement of levers with gear segment # with ramp as mounting aid # with adjusting ring at frame (Ø 23mm)	capacity up to <b>60kg</b> (wheelchair incl. payload) size 1: frame straight SW 26cm - 28cm frame abduction SW 24cm - 28cm size 2: seat width 30cm - 34cm <b>CODE 9921</b>	capacity up to <b>90kg</b> (wheelchair incl. payload) size 3: seat width 36cm - 40cm Größe 4: Sitzbreite 42cm - 46cm <b>CODE 9922</b>
<input type="checkbox"/> Piece 498,- €	<input type="checkbox"/> Piece 639,- €		

**Note:**

Junior2 AR: combination TRIKE with anchor plate system is **not possible !!**

Junior2 SLT: combination TRIKE (hook) with anchor plate system is from frame long (from SD 34) possible !!  
 combination TRIKE (clamp) with anchor plate system is possible !!

Technical changes and print mistakes reserved.

VD2359E-41

note

Technical changes and print mistakes reserved.

VD2359E-40

## General Terms and Conditions of Business (GTC)

### Validity

All sales are subject to our delivery and payment conditions, without any exception. Orders and other agreements will not be valid unless confirmed by us in writing. We expressly object to the customer's purchase conditions.

### Quotations and contract conclusion

Quotations are always subject to change, unless they are expressly limited in terms of time. Orders require a written confirmation. After confirmation, prices quoted in orders are fixed but we reserve the right to make adequate price adjustments in the event of price increases for which we are not responsible (e.g. tax increases, wage increases, price changes on the part of our suppliers). Cost estimates for customized products and repairs are always non-binding. We reserve the right to make technical modifications. The contract will not be concluded before the order is confirmed.

### Shipment

To the extent the customer has not made any specification, shipment will be made in usual packaging using an adequate method. Insurance will only be taken out upon request and at the expense of the customer.

Delivery will be made carriage forward. We are free to select a method of shipment. If the customer has special requests, e.g. express delivery, express freight, etc., the additional cost will also be borne by the recipient. The goods will always be shipped at the buyer's risk. In case of damage during transport, the recipient must apply for an ascertainment of the facts with the respective forwarding agent.

### Prices

All prices quoted by BEROLLKA will be quoted ex works, excluding any applicable statutory value added tax, public charges and levies such as potential customs tariffs, and insurance and packaging costs that will be charged separately.

### Minimum quantity surcharge

If a small order is placed with a net value below 20 euros, an additional lump-sum minimum quantity surcharge of 15.00 euros will additionally be charged to cover administrative costs.

### Delivery periods

The delivery dates and periods stated are subject to change. Any delay in delivery will not entitle the customer to withdraw from the contract. The assertion of damage claims is ruled out. BEROLLKA can make partial deliveries for justified reasons.

### Wrong orders / return of merchandise

Any goods erroneously ordered will only be taken back provided we are responsible for such an error and the merchandise is in impeccable condition. In the event that an item erroneously ordered or merchandise that was returned is taken back in an individual case as a gesture of goodwill, attention must be paid to the following:

1. It is necessary to state the article number, the designation of the article, the date and number of the delivery note and the invoice number.
2. The return shipment must be carriage paid.
3. The merchandise must correspond to the article number(s) listed in the delivery note. In no event will any individual parts removed from an article be taken back.
4. The returned merchandise must be in impeccable condition.
5. Processing fees amounting to 10% of the net merchandise value not, however, less than €35.- will be charged for any instance where goods are taken back.

Deliveries effected more than 3 months earlier as well as sewing pieces and customized products cannot be exchanged. A copy of the delivery note or of the invoice will serve as proof in this regard.

### Warranty and notices of defects

Excluding any further claims, the seller is liable for defects of the merchandise in that the seller will mend or replace all those parts free of charge that have become defective or unusable within 6 months due to provable defects of material or workmanship, and of which the seller has been notified in writing immediately after knowledge was gained of the defect. Should longer periods of time be required for statutory reasons, the warranty period is agreed to be 12 months.

The customer must grant the seller the required time and opportunity for effecting delivery of the replacement parts. Replaced parts will become the property of the seller. The buyer must check the merchandise without undue delay after it has been delivered by the seller and, if a defect is found, notify the seller of the defect without undue delay. Should the buyer fail to notify the seller, the merchandise will be deemed accepted unless a defect occurs that could not have been found when the merchandise was checked.

In any event in which a complaint is brought to the notice of BEROLLKA, BEROLLKA invariably has the right to inspect and check the item delivered that is the subject matter of said complaint, for which the customer will grant BEROLLKA the required time and opportunity. BEROLLKA can also demand that the customer sends the item delivered that is the subject matter of a complaint back to BEROLLKA at the expense of BEROLLKA. Should a notice of defects given by the customer turn out to be wilfully or gross negligently unfounded, the customer will be obliged to compensate BEROLLKA for any and all expenses incurred in this connection. BEROLLKA will be entitled to remedy warranty defects at its own discretion either by rectification of the defect or by replacement of the defective part or of the entire item delivered at no cost for the customer. Should the customer itself repair an item that gave rise to a complaint, or should the customer endeavour to rectify the defects itself without prior written approval of the seller, the seller will not grant any claims for reimbursement of expenses (such as transport, road, labour or material costs) or warranty claims.

The following are excluded from the liability for damages:

damage arising from natural wear and tear, damage due to negligent and/or improper treatment, or violent damage. A revocation of the purchase contract, a reduction of the purchase price or damage claims of any kind are ruled out. The warranty obligation will cease if repairs and/or modifications or replacements of individual parts are performed by other parties than the seller or the delivering company.

### Reservation of title

With regard to resellers: The merchandise delivered will remain our property until any and all invoices – also for different deliveries – have been fully paid. Our merchandise that is hence still our property may only be resold within the ordinary course of business. Amounts receivable from any resale are assigned to us. We must be notified without undue delay and on the reseller's own initiative of any disposal of said merchandise outside of the ordinary course of business, e.g. through pledging our property or amounts receivable assigned to us.

### Terms of payment

Any invoices are payable within 30 days from the date of the invoice strictly net cash. A 2% discount will be granted for payments received within 8 days provided any and all payment claims under earlier deliveries have been settled. We are entitled to charge default interest if the 30-day payment deadline is exceeded. The interest rate will be the customary market rate charged by major banks. We expressly reserve the right to effect delivery with cash on delivery.

### Data Protection

BEROLLKA and the customer are responsible themselves for compliance with the respective data protection rules applicable to them. The customer must not provide BEROLLKA with personal data that is illegal or that the customer is not legally authorised to distribute.

### The place of performance and the place of jurisdiction will be the place where the invoice is issued.

Heidelberg, Germany, will be the exclusive place of jurisdiction for any and all disputes arising under the contractual relationship. However, BEROLLKA is entitled to sue the customer at any other legal venue. These General Terms and Conditions of Business are governed by the laws of the Federal Republic of Germany, excluding of the United Nations Convention on Contracts for the International Sale of Goods of Goods (CISG).

Technical modifications and printing errors excepted. A current list of prices can be ordered at any time.